



Status, Results, and Future Plans for LIGO and Virgo

YKIS2018a, Kyoto
19 February 2018

David Shoemaker
For the LIGO and Virgo Scientific Collaborations

Credits

Measurement results: LIGO/Virgo Collaborations,
PRL 116, 061102 (2016); Phys. Rev. Lett. 119, 161101 (2017);
Phys. Rev. Lett. 119, 141101 (2017); Phys. Rev. Lett. 118, 221101 (2017);
Phys. Rev. Lett. 116, 241103 (2016)
Simulations: SXS Collaboration; LIGO Laboratory
Localization: S. Fairhurst arXiv:1205.6611v1
Slides from (among others) L. Nuttall, P. Fritschel, L. Cadonati
Photographs: LIGO Laboratory; MIT; Caltech; Virgo

Virgo and LIGO

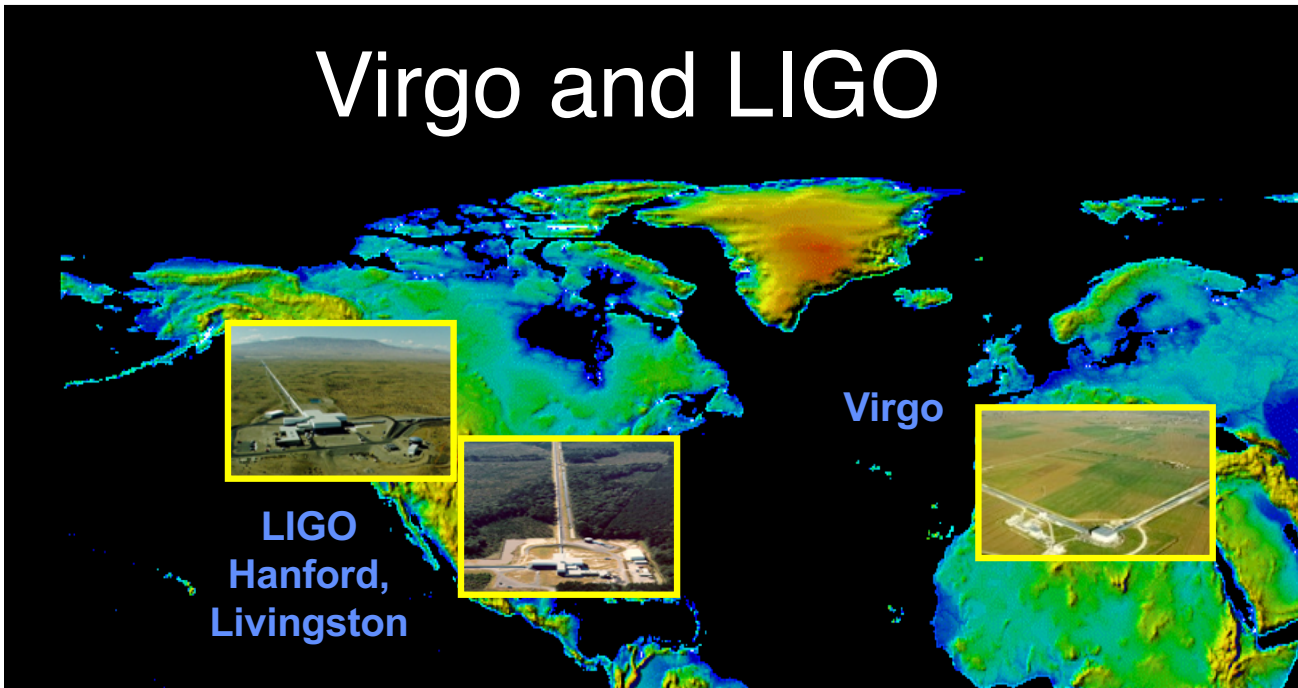

Virgo and LIGO built
new observatories in
the 90's

LIGO thanks the NSF for
its vision and support!



Virgo and LIGO

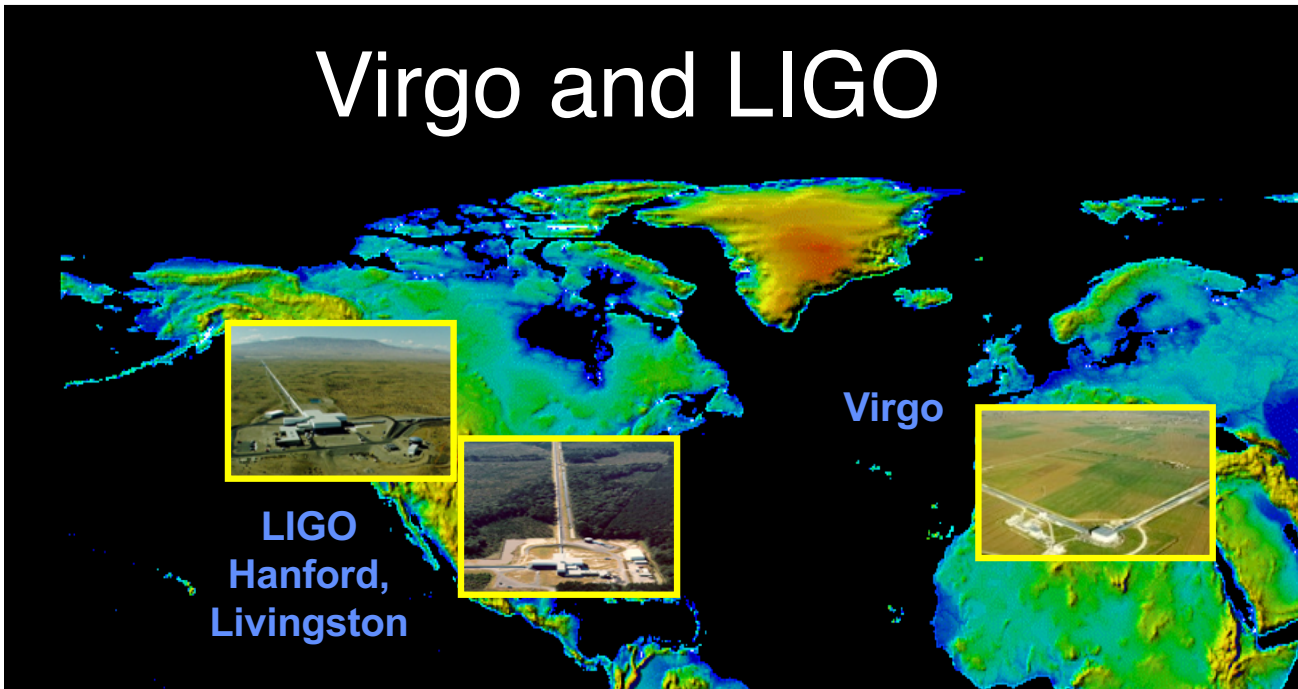

Virgo and LIGO built
new observatories in
the 90's

...and Observed with the initial detectors
2005-2011,
and saw **no signals**

(with some interesting non-detections)



Advanced Detectors: *a qualitative difference*

- Foreseen in original 1989 LIGO proposal
- While observing with initial detectors, parallel R&D led to better concepts
- Design for **10x better sensitivity**

- We measure amplitude, so signal falls as $1/r$
- **1000x more candidates**

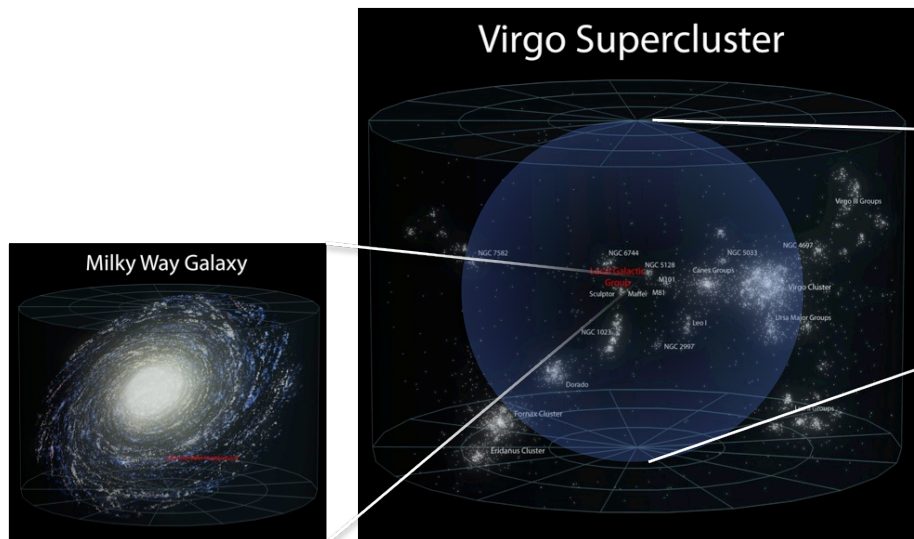

M. Evans

Initial Reach

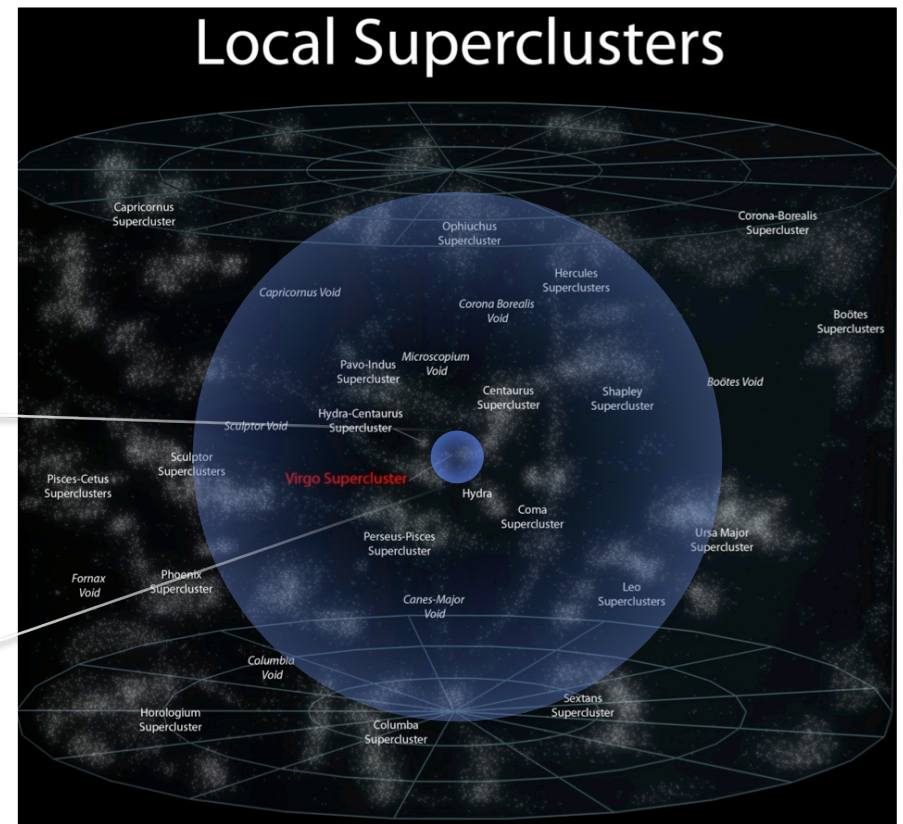

Advanced Reach

What is our measurement technique?

- Enhanced **Michelson interferometers**
 - » LIGO, Virgo use variations
- GWs modulate the distance between the end test mass and the beam splitter
- The interferometer acts as a transducer, turning GWs into photocurrent proportional to the strain amplitude
- **Arms are short compared to our GW wavelengths, so longer arms make bigger signals**
→ multi-km installations
- Arm length limited by taxpayer noise....

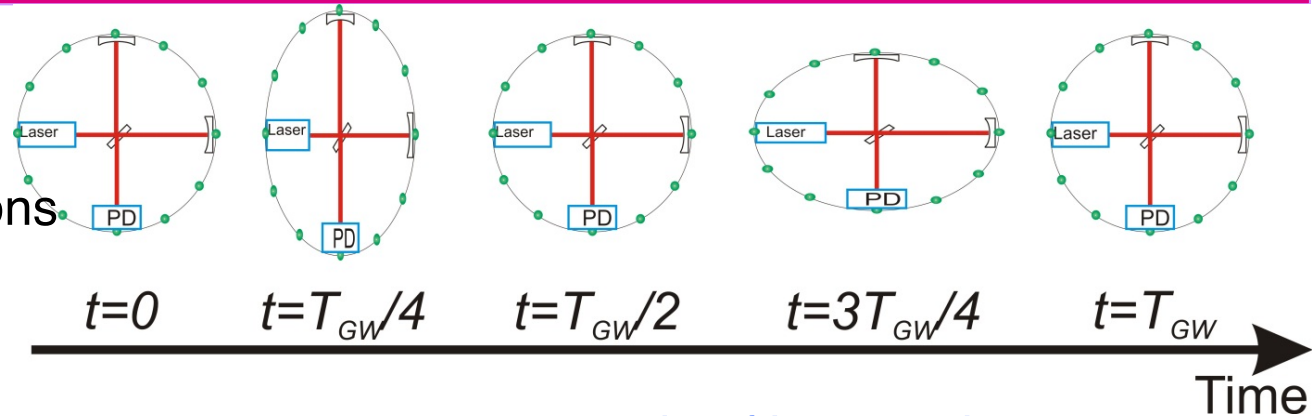

$$h \approx \frac{\Delta L}{L}$$

Magnitude of h at Earth:
 Detectable signals $h \sim 10^{-21}$
 (1 hair / Alpha Centauri)
 For $L = 1 \text{ m}$, $\Delta L = 10^{-21} \text{ m}$
 For $L = 4 \text{ km}$, $\Delta L = 4 \times 10^{-18} \text{ m}$

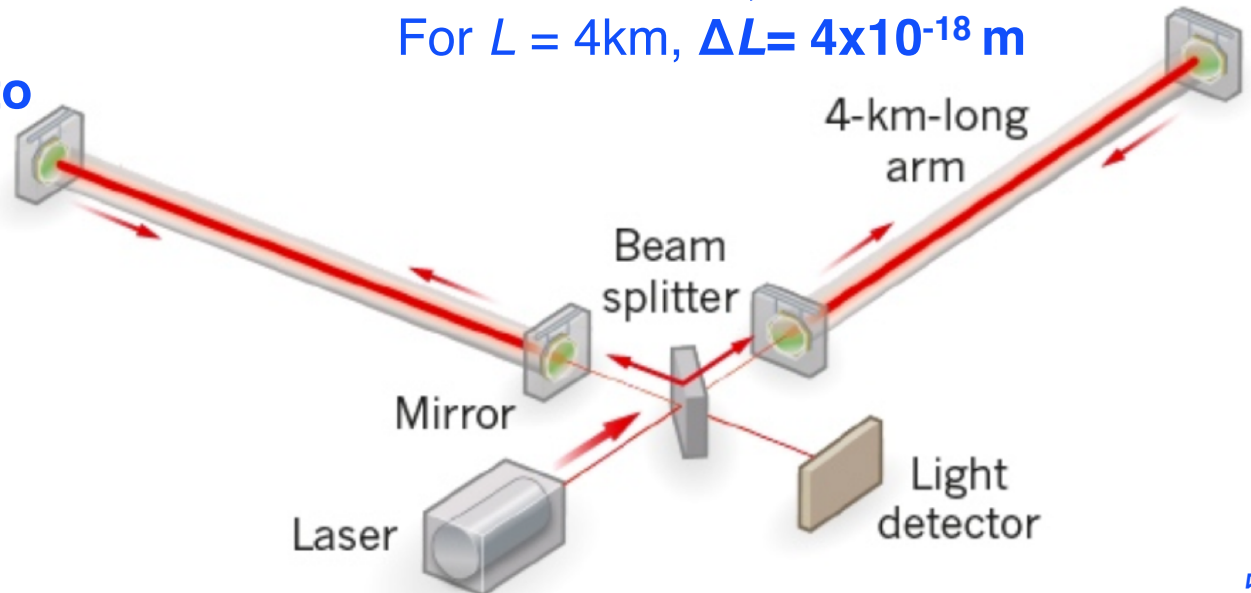

L. Barsotti - March 9, 2012
Adapted from G1200071-v1

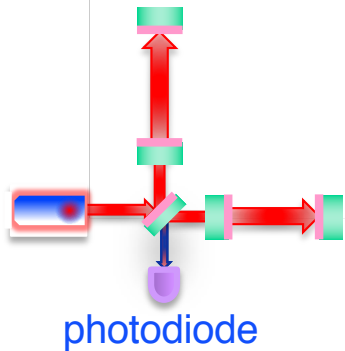
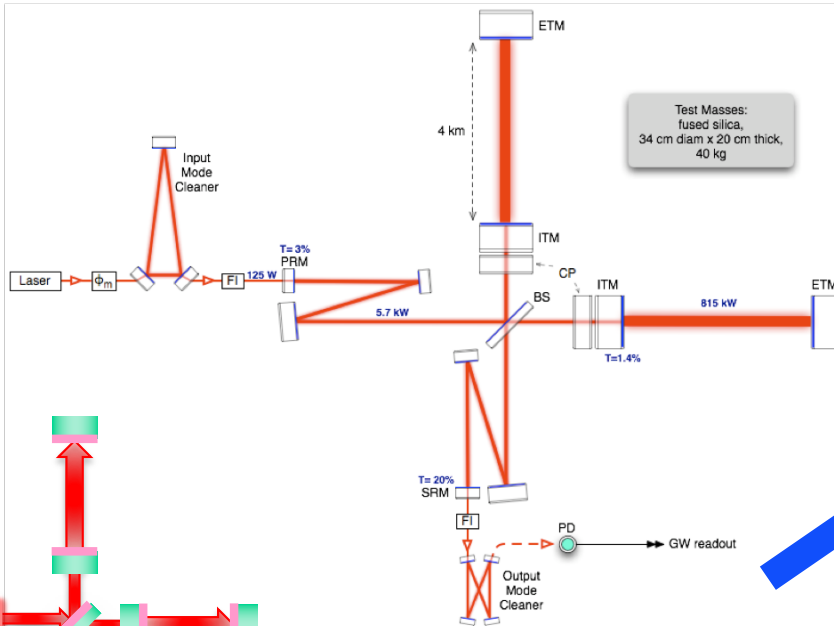
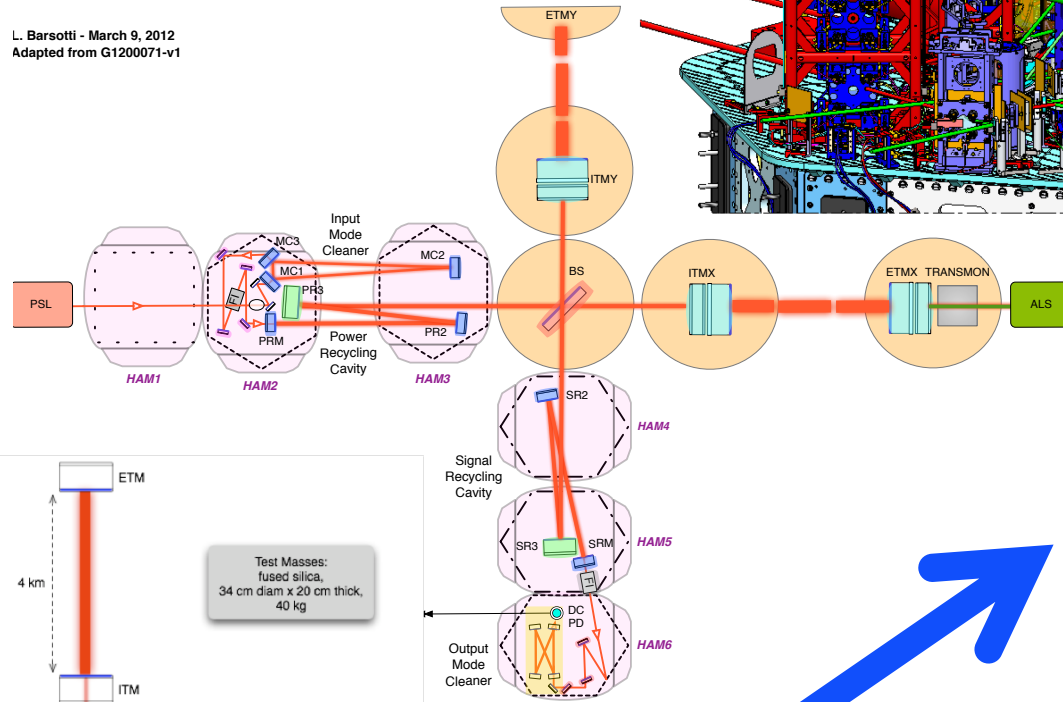
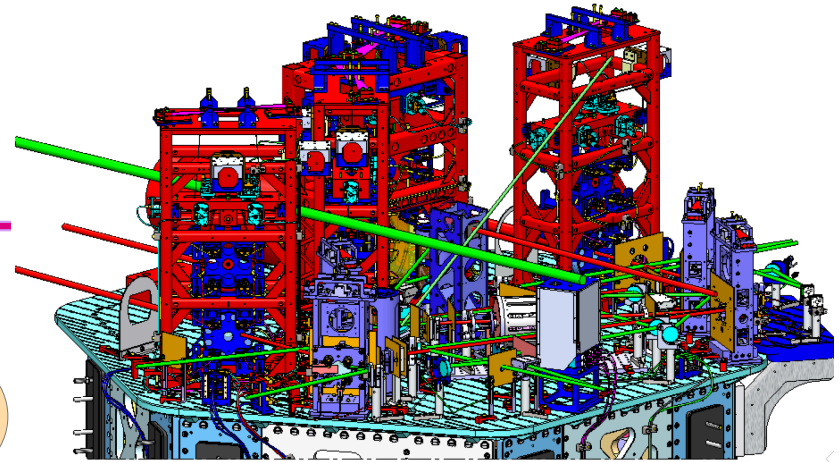

photodiode



The real instrument is also more complex than a simple Michelson...



Measuring $\Delta L = 4 \times 10^{-18}$ m Readout

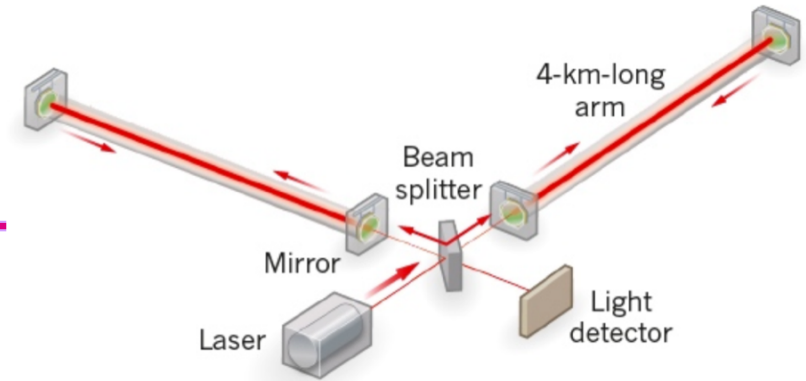

- **Shot noise** – ability to resolve a fringe shift due to a GW (counting statistics)
- *Zum gegenwärtigen Stand des Strahlungsproblems, A. Einstein, 1909*
- Fringe Resolution at high frequencies improves as as $(\text{laser power})^{1/2}$

$$h_{\text{sn}}(f) = \frac{1}{L} \sqrt{\frac{\hbar c \lambda}{2\pi P}}$$

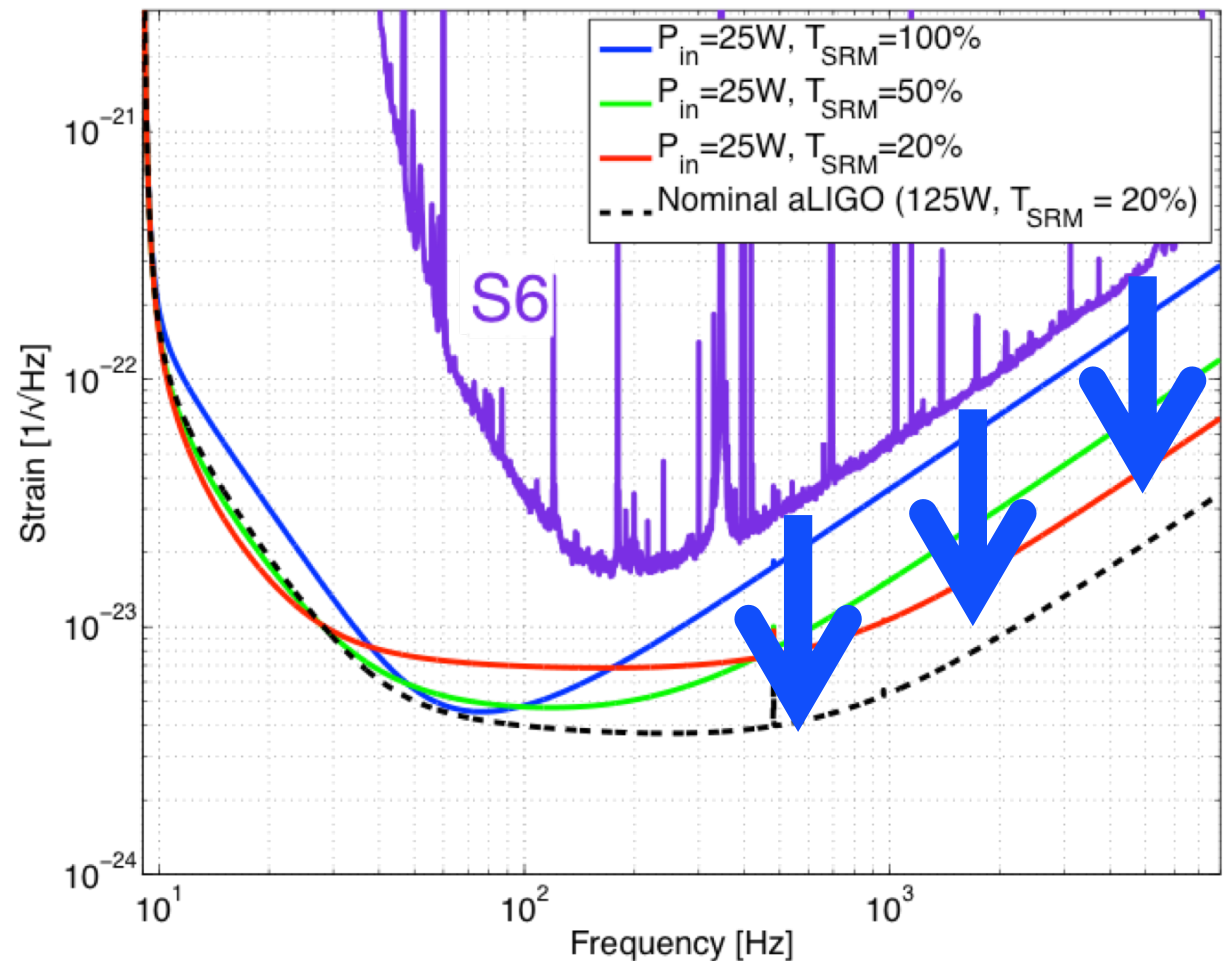

Measuring $\Delta L = 4 \times 10^{-18}$ m Readout

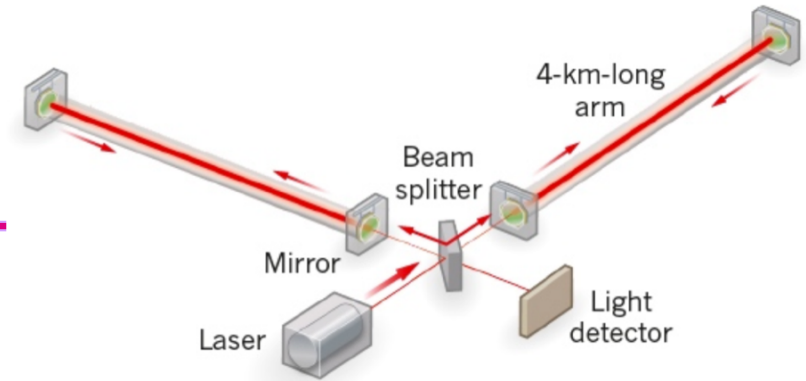

- Shot noise – ability to resolve a fringe shift due to a GW (counting statistics)

$$h_{\text{sn}}(f) = \frac{1}{L} \sqrt{\frac{\hbar c \lambda}{2\pi P}}$$

- **Radiation Pressure noise** – Point of diminishing returns when buffeting of test mass by photons increases low-frequency noise – use heavy test masses!

$$h_{\text{rp}}(f) = \frac{1}{m f^2 L} \sqrt{\frac{\hbar P}{2\pi^3 c \lambda}}$$

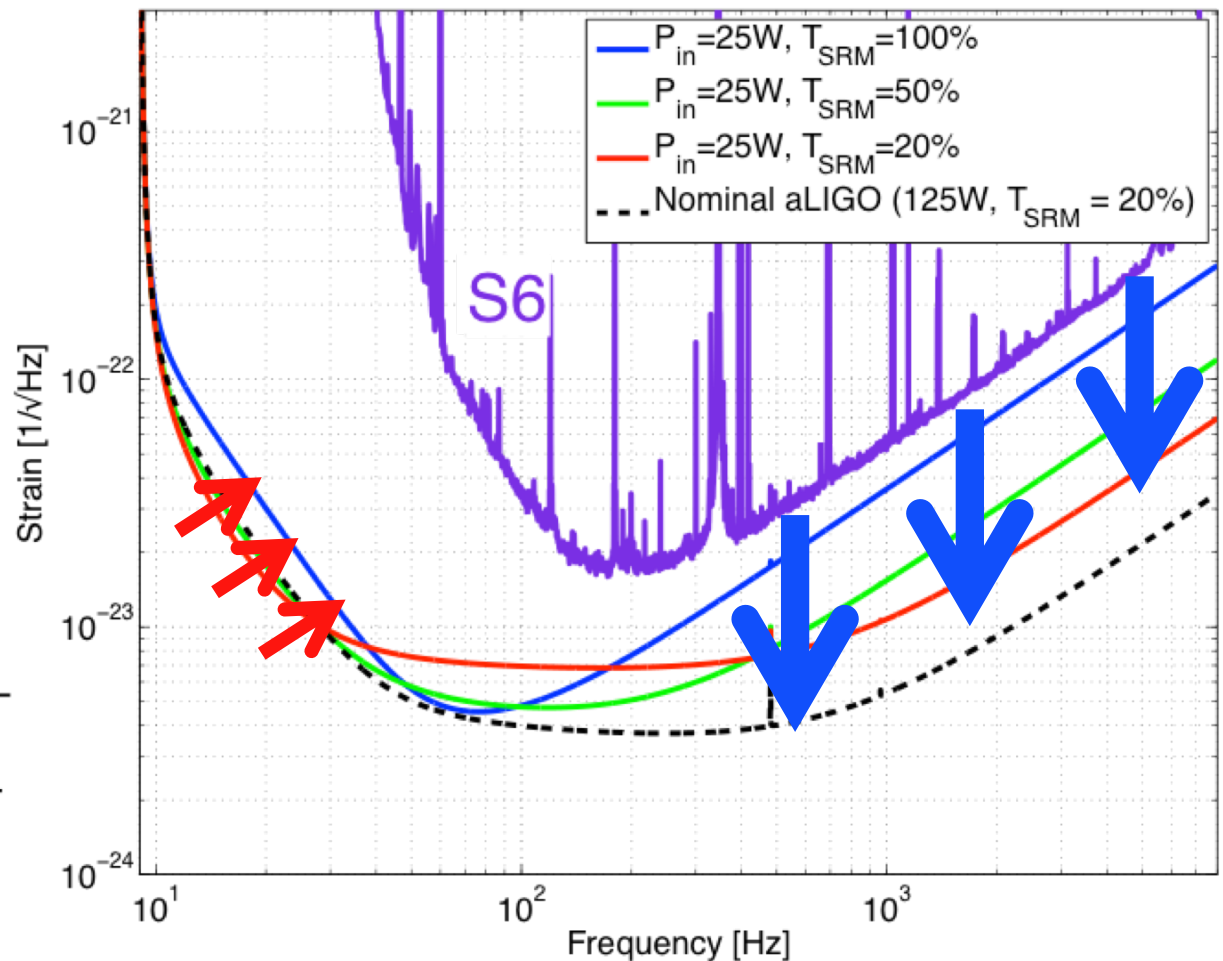

Measuring $\Delta L = 4 \times 10^{-18}$ m

Internal motion

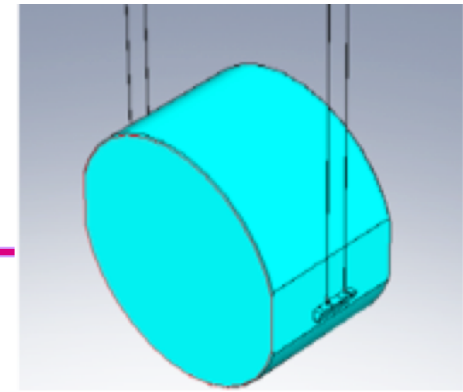

- **Thermal noise** – kT of energy per mechanical mode
- *Über die von der molekularkinetischen Theorie der Wärmegeforderte Bewegung von in ruhenden Flüssigkeiten suspendierten Teilchen, A. Einstein, 1905*
- Simple Harmonic Oscillator:

$$x_{rms} = \sqrt{\langle (\delta x)^2 \rangle} = \sqrt{k_B T / k_{spring}}$$

- Distributed in frequency according to real part of impedance $\Re(Z(f))$

$$\tilde{x}(f) = \frac{1}{\pi f} \sqrt{\frac{k_B T}{\Re(Z(f))}}$$

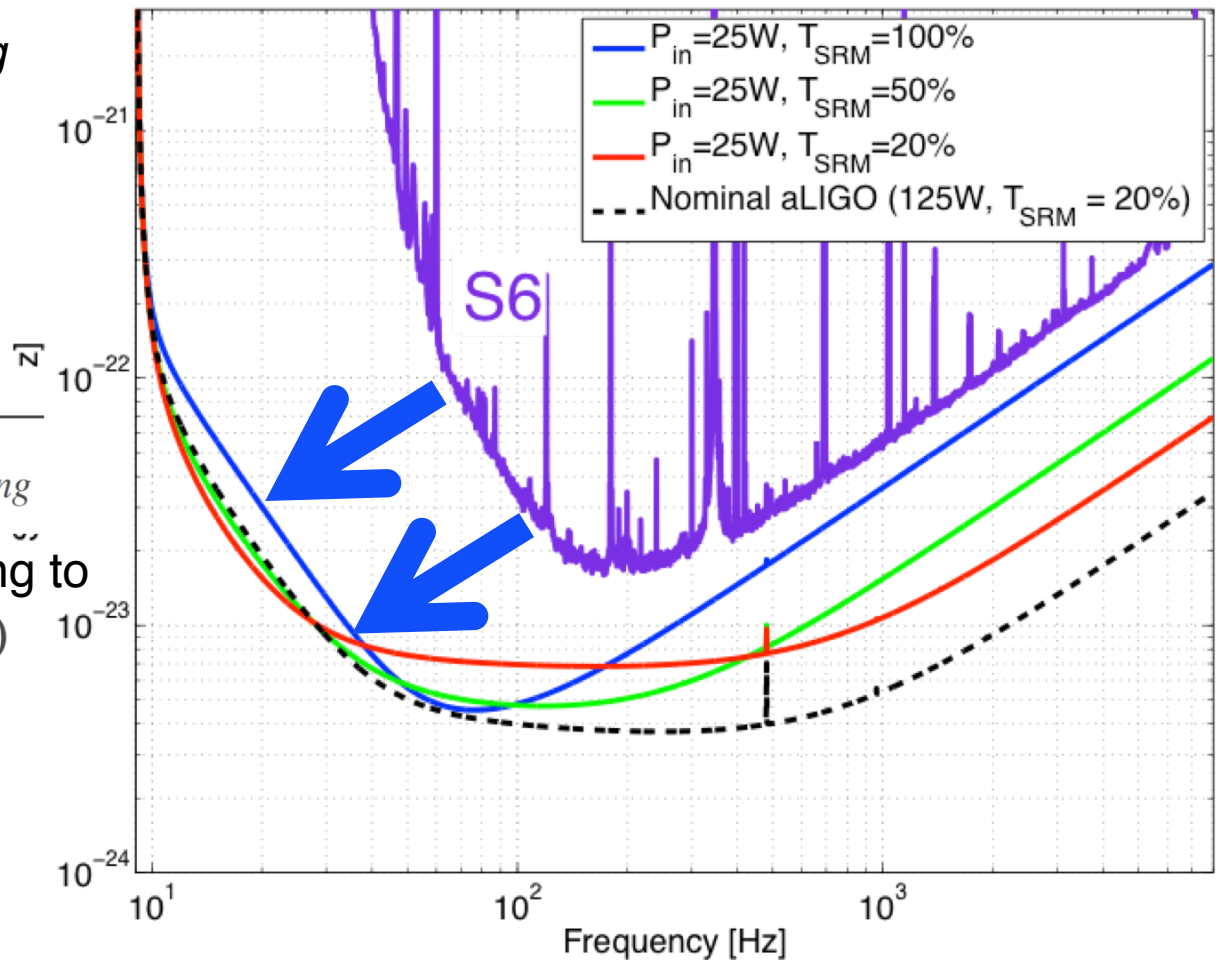

Measuring $\Delta L = 4 \times 10^{-18}$ m

Internal motion

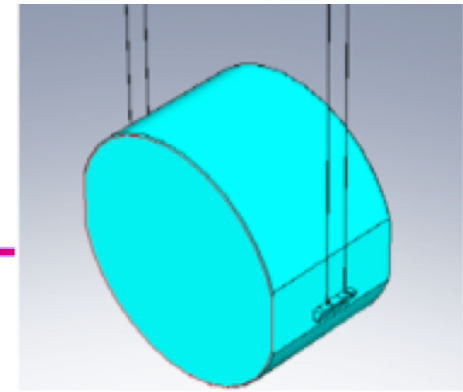

- In Advanced LIGO, the dielectric optical coating has a rather large loss tangent
 - » Some 10^{-4}
- And: the coating is the surface that is sensed by the laser
- **This is the dominant limit in the critical 50-200 Hz band**

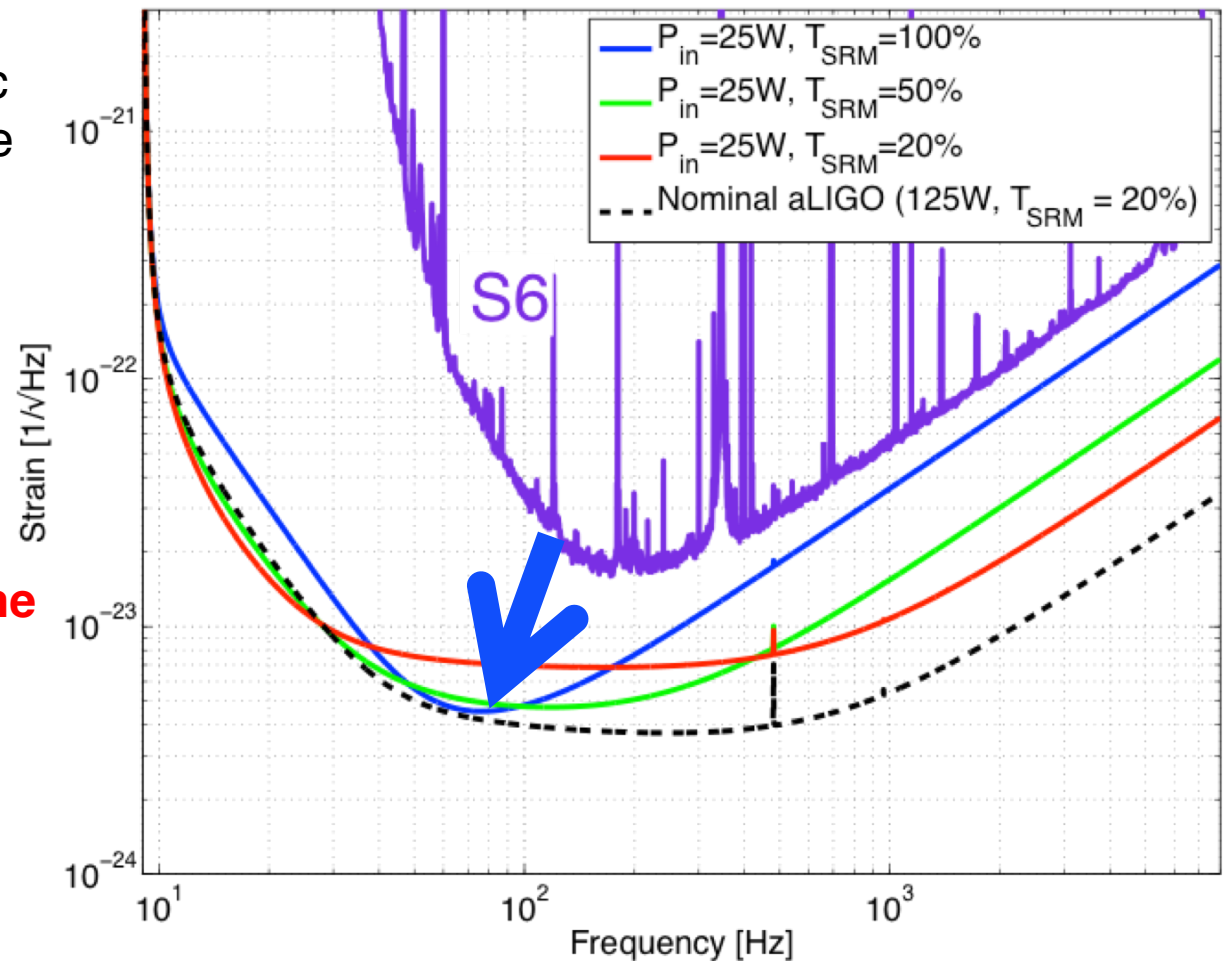



Measuring $\Delta L = 4 \times 10^{-18}$ m

Forces on test mass

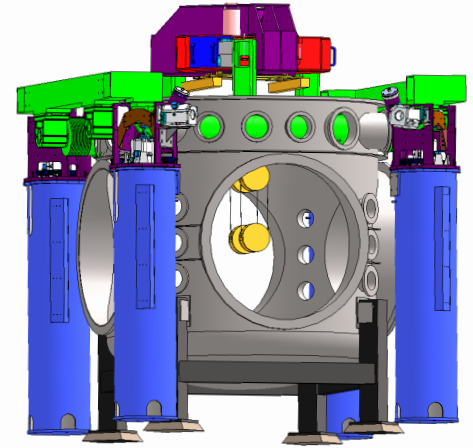

- **Seismic noise** – must prevent masking of GWs, enable practical control systems
- aLIGO uses **active servo-controlled platforms, multiple pendulums**
- 3 layers, each of 6 degrees-of-freedom

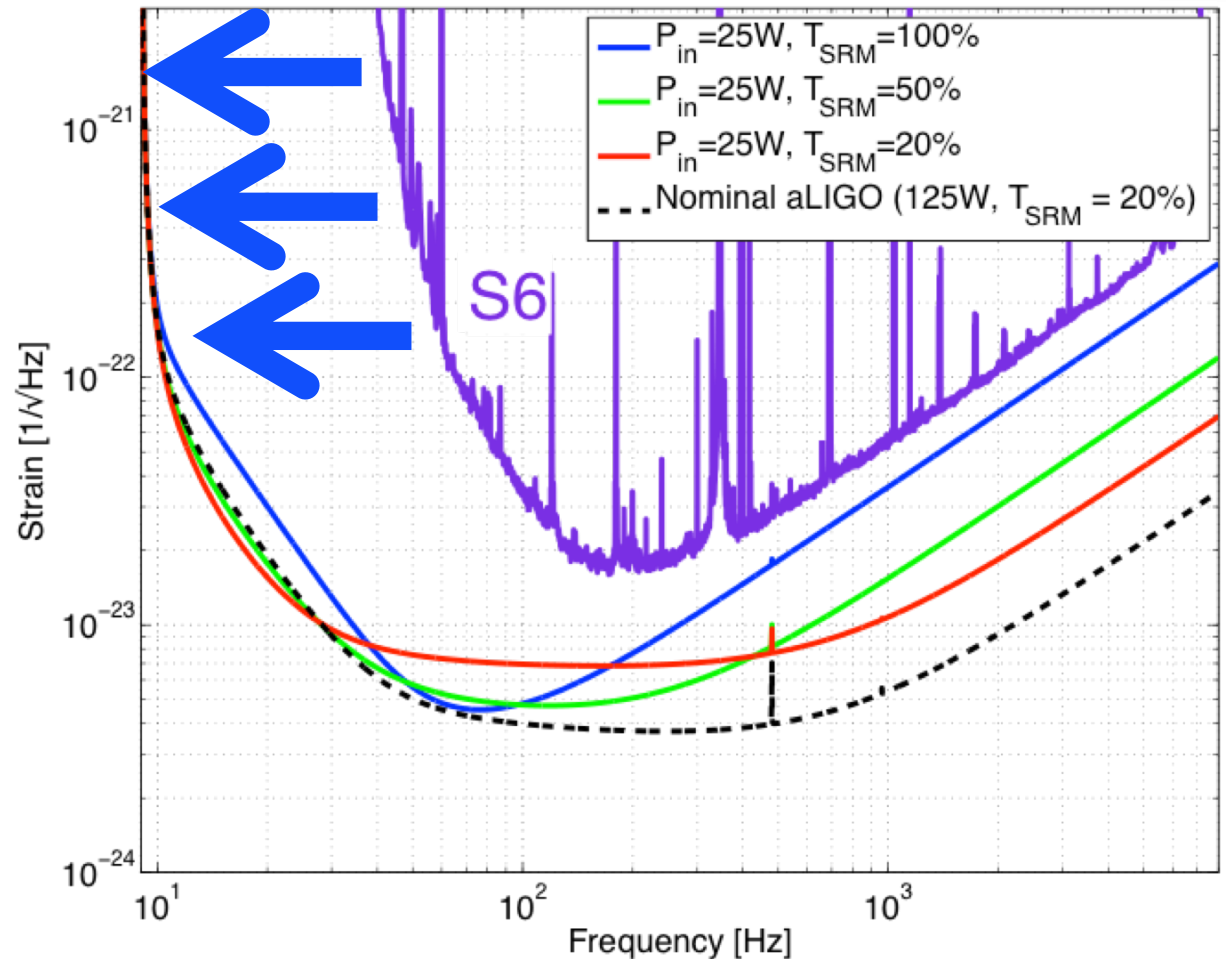

Measuring $\Delta L = 4 \times 10^{-18}$ m

Forces on test mass

- Ultimate limit on the lowest frequency detectors on- or under-ground:
- Newtownian background – wandering net gravity vector; a limit in the 10-20 Hz band

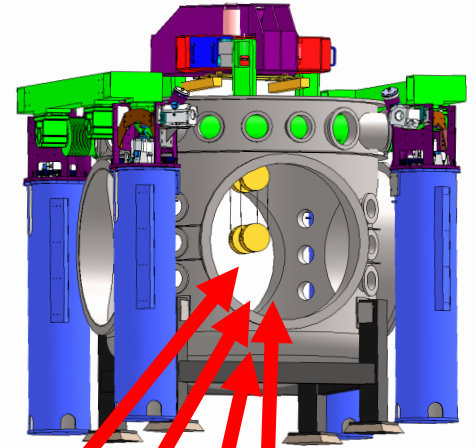

Body waves

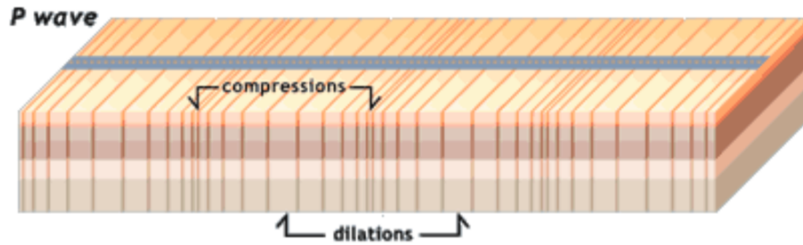

Rayleigh waves

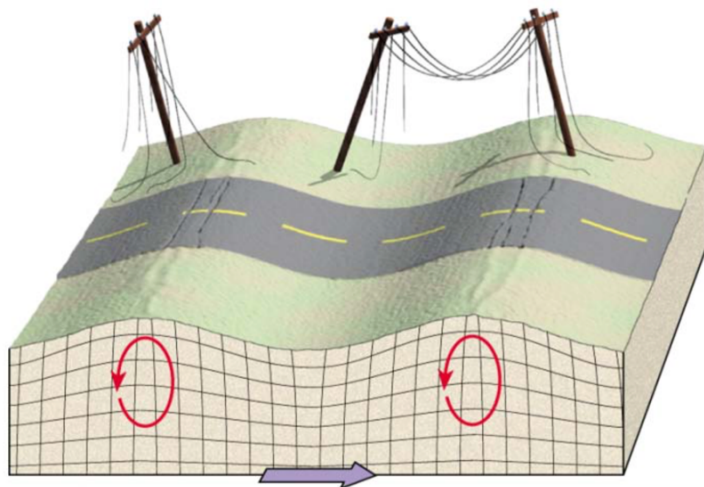

LIGO-G1800255-v1

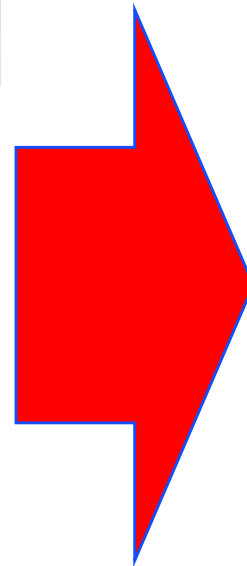

Density perturbation

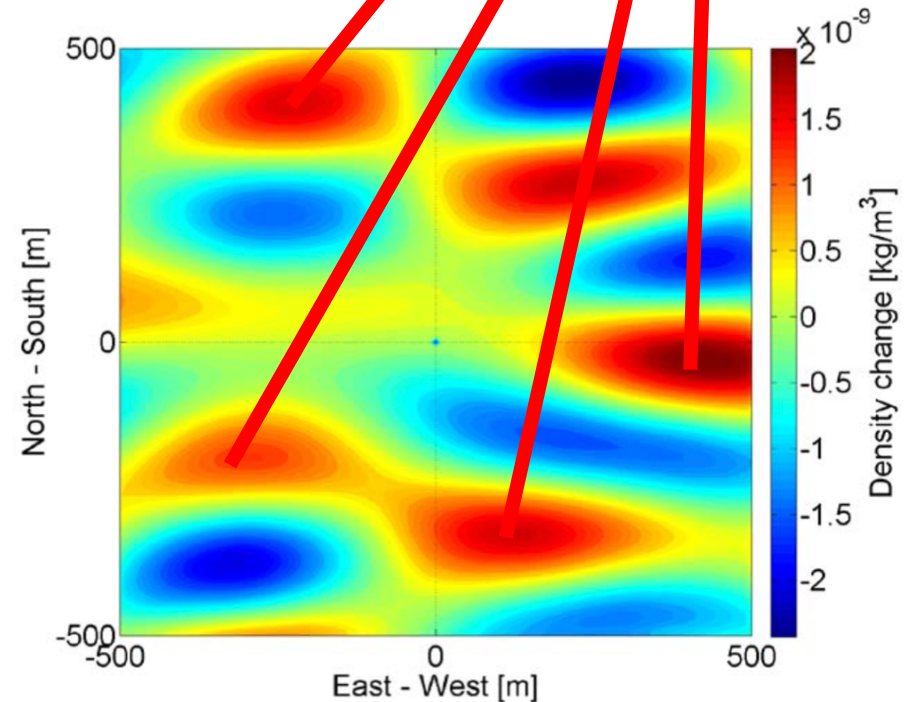

Density perturbations cause gravity perturbations.

Images: J. Harms

Measuring $\Delta L = 4 \times 10^{-18}$ m

Forces on test mass

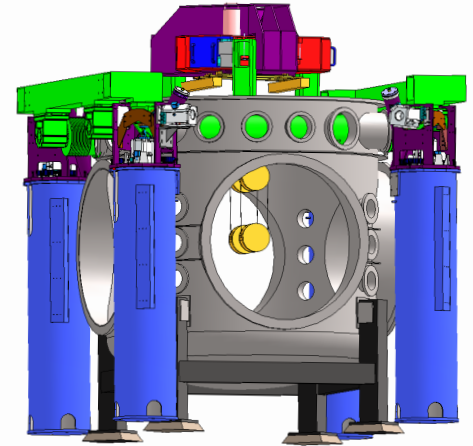

- Advanced LIGO (and Virgo) expect to be limited by this noise source –
 - » After all technical noise sources beaten down
 - » At low optical power (no radiation pressure noise)
 - » In the 10-30 Hz range
- **We would love to be limited only by this noise source!**
- Want to go a bit lower?
Go underground.
- Want to go much lower?
Go to space.

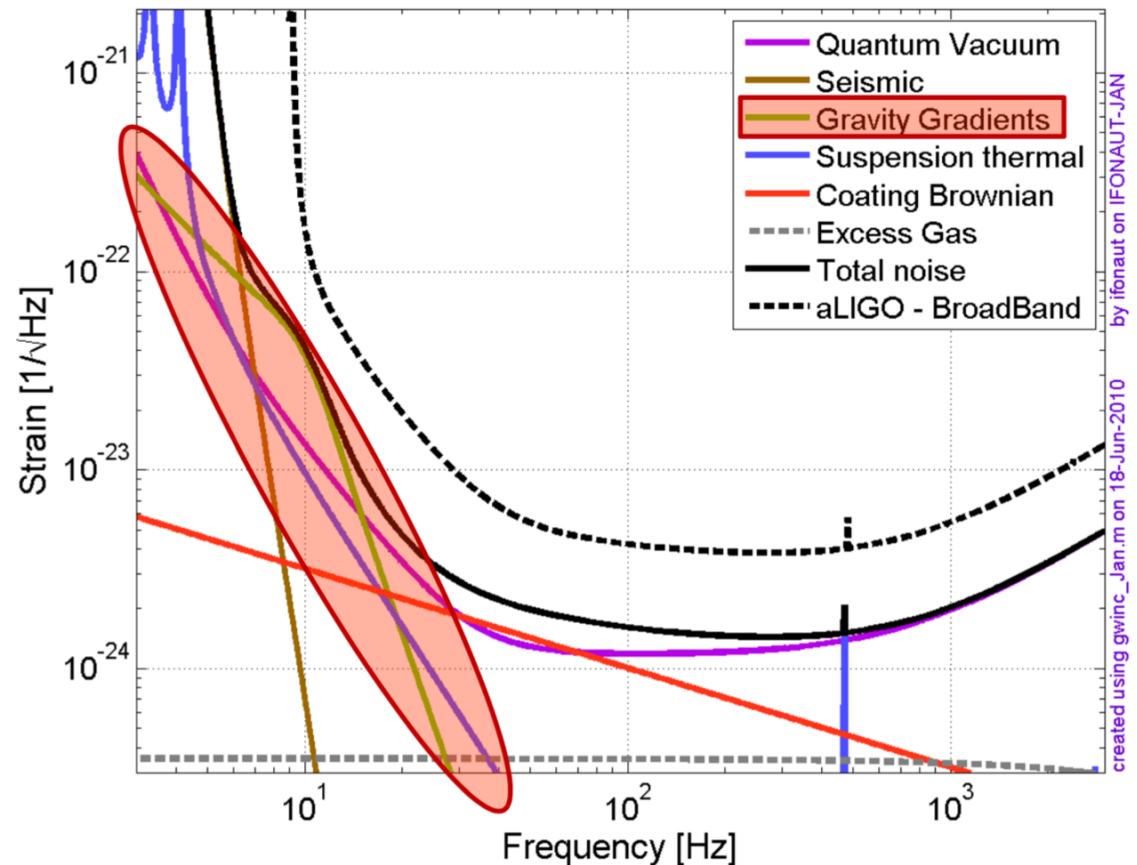



Adv LIGO Target Design

Sensitivity, basic noise sources

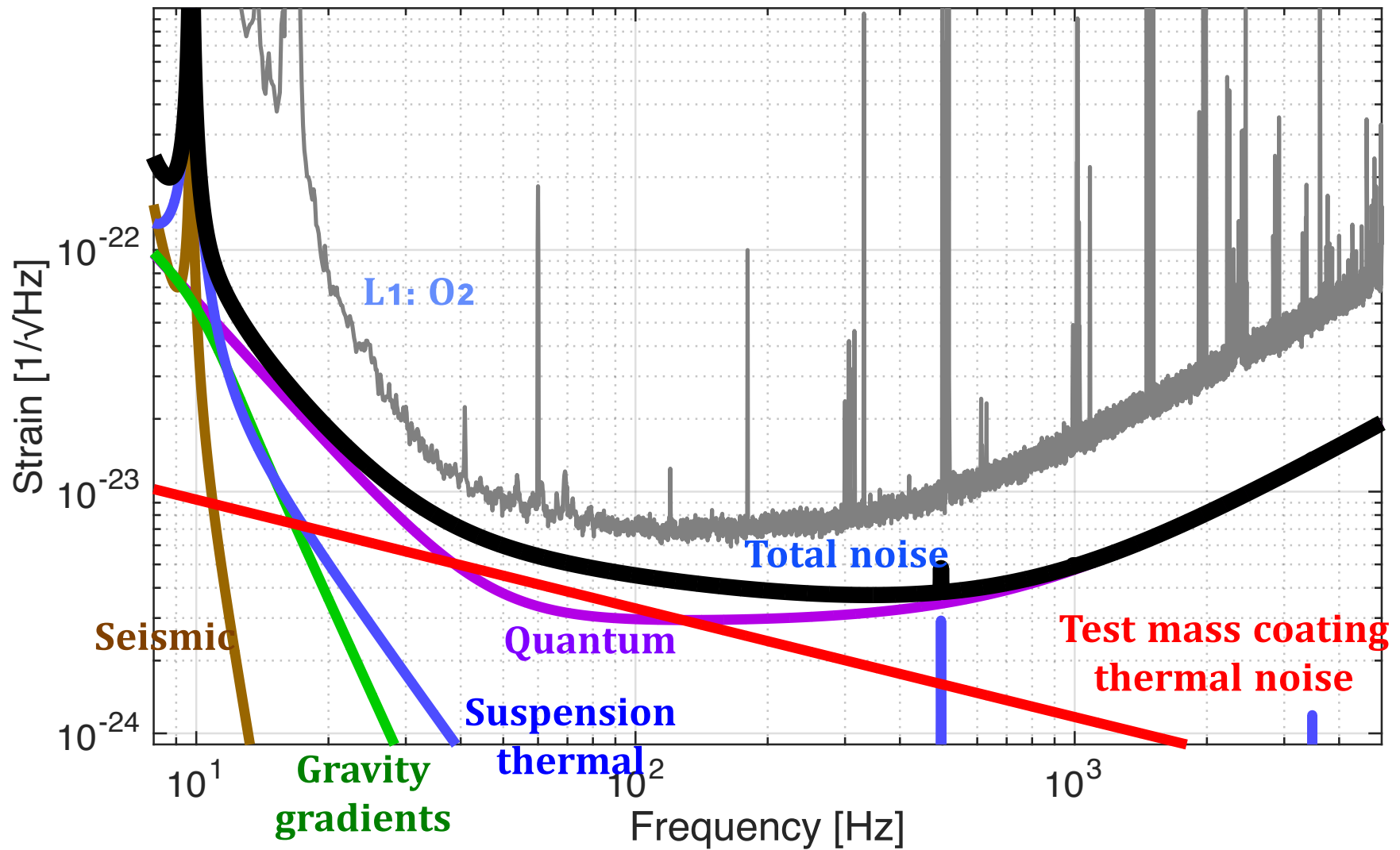

Then there are the technical noise sources....

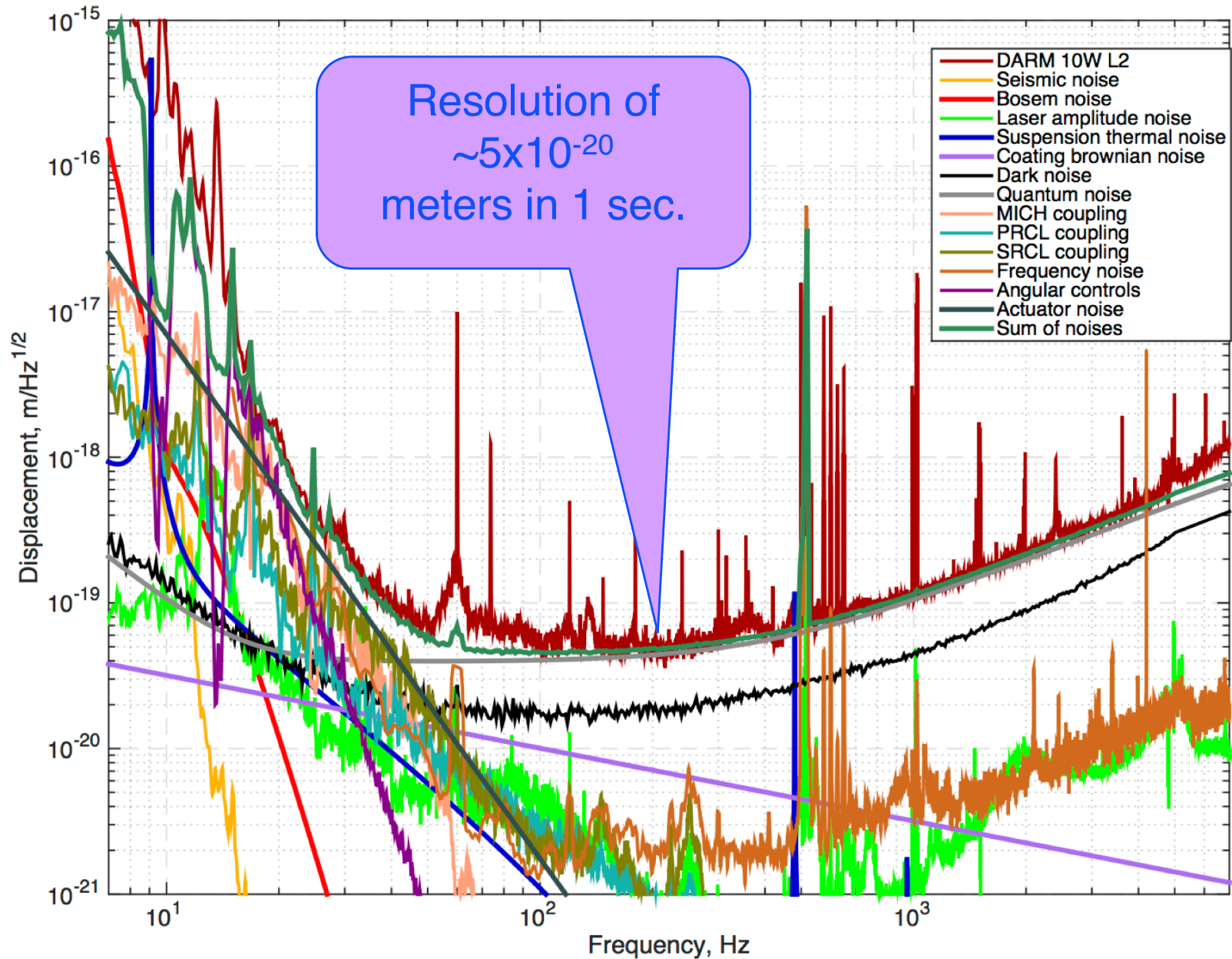



Sensitivity for first Observing runs

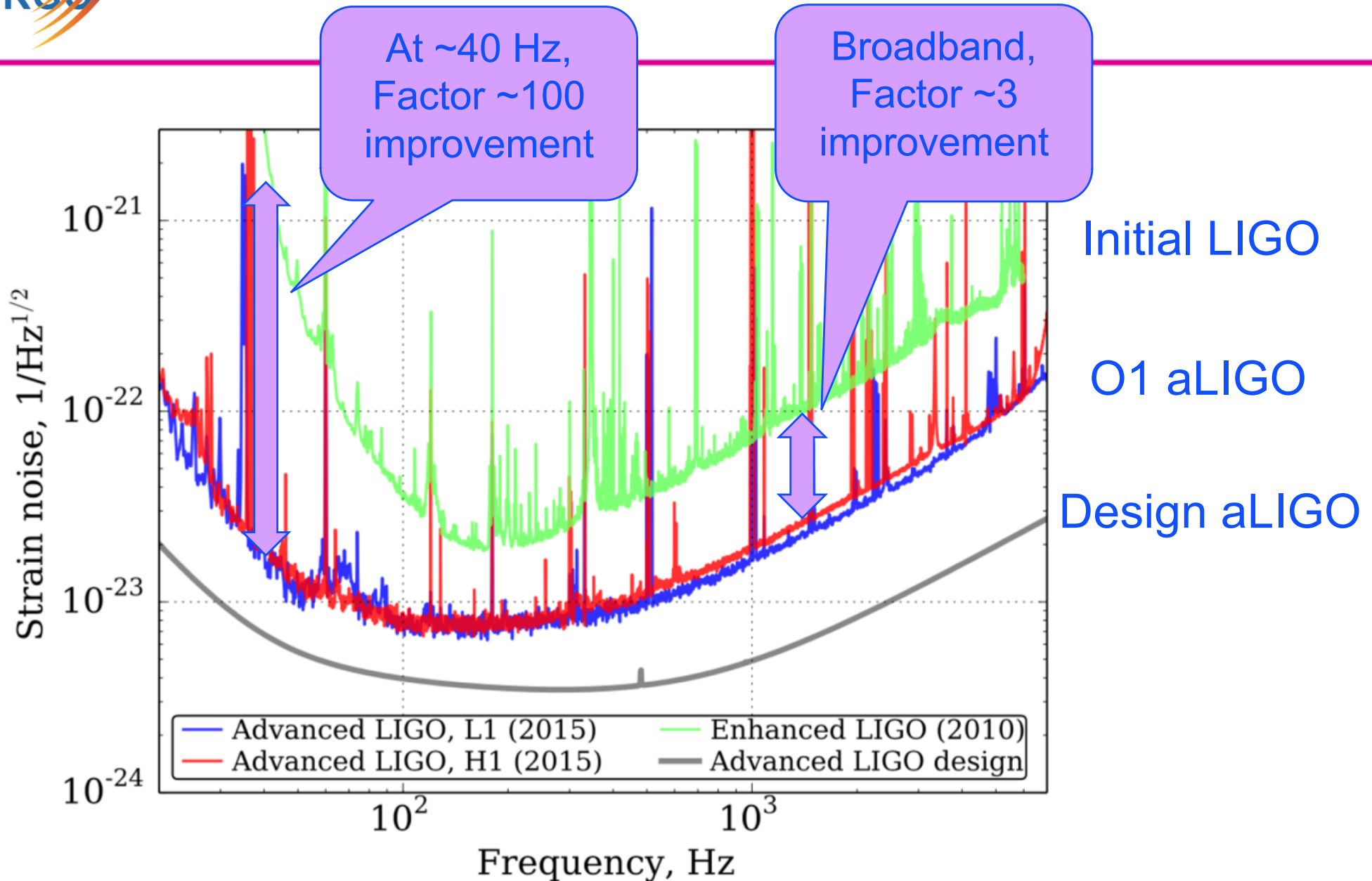

The first signal

On September 14, 2015 at 09:50:45 UTC the two detectors of the Laser Interferometer Gravitational-Wave Observatory observed a transient gravitational-wave signal

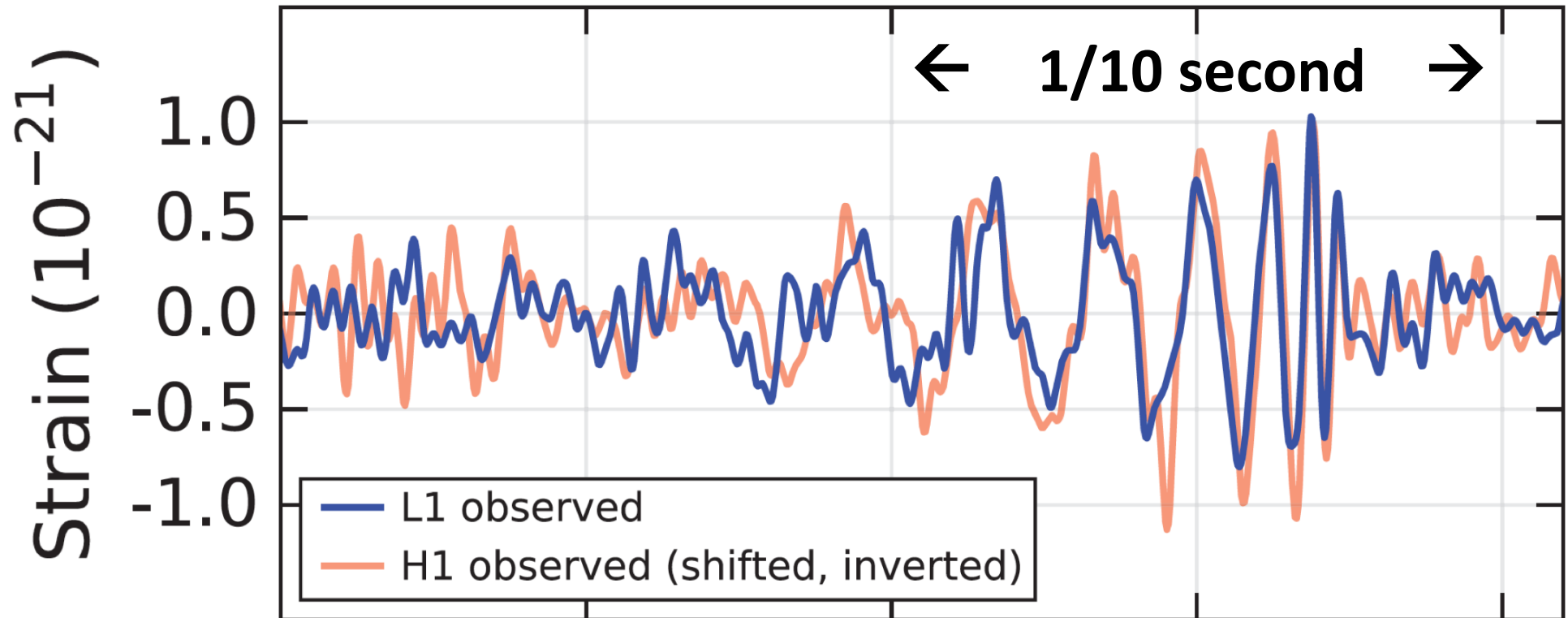

We measure $h(t)$ – think ‘strip chart recorder’

- The output of the detector is the (signed) strain as a function of time
- Earlier measurements of the pulsar period decay (Taylor/Hulse/Weisberg) measured energy loss from the binary system – a beautiful experiment
 - » radiation of gravitational waves confirmed to *remarkable* precision for 0th post-Newtonian
- **LIGO can actually measure the change in distance between our own test masses, due to a passing space-time ripple**
 - » Instantaneous amplitude rather than time-averaged power
 - » Much richer information!

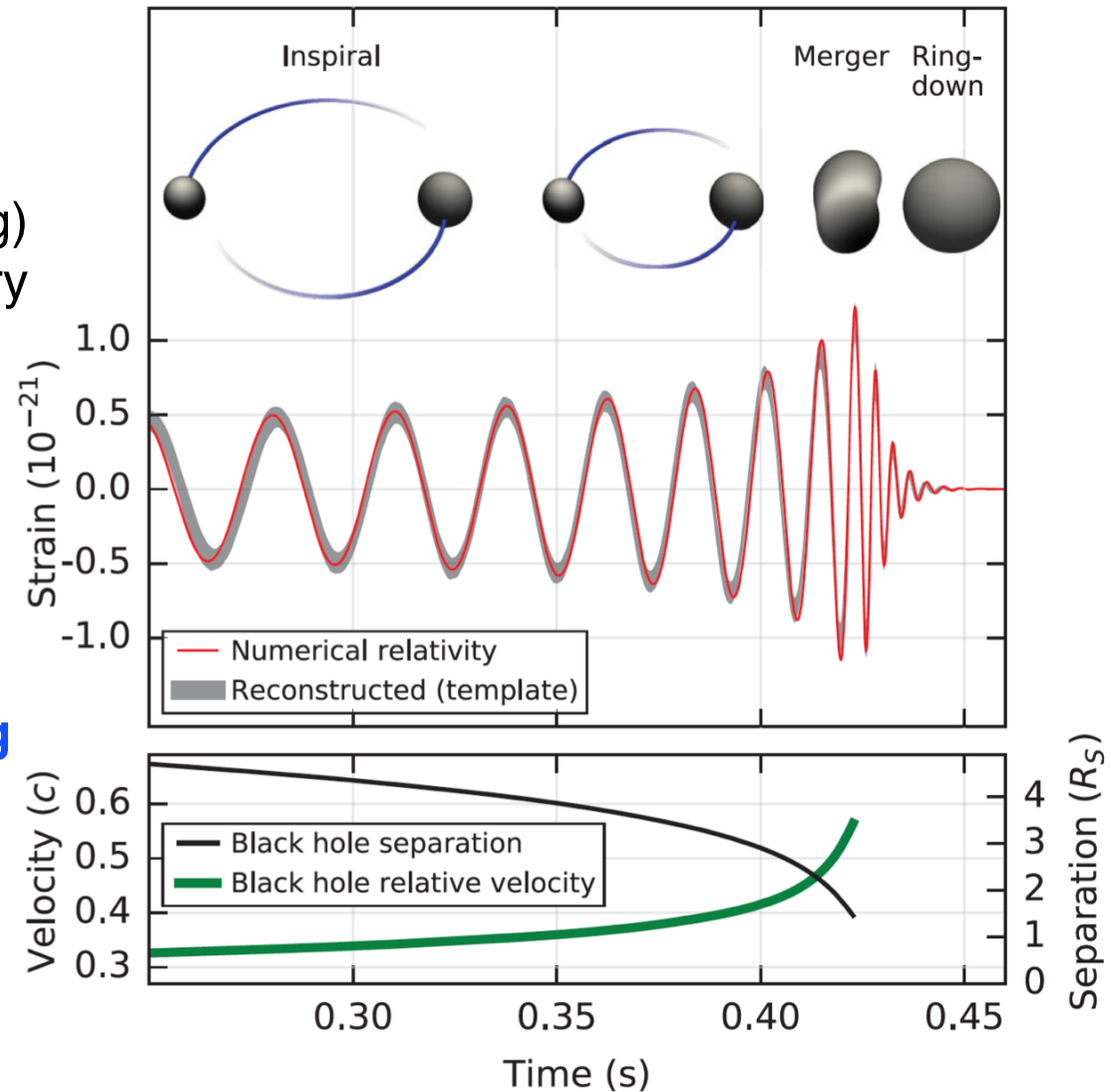



GW170814

The first GW signal observed by LIGO-Hanford, LIGO-Livingston and Virgo

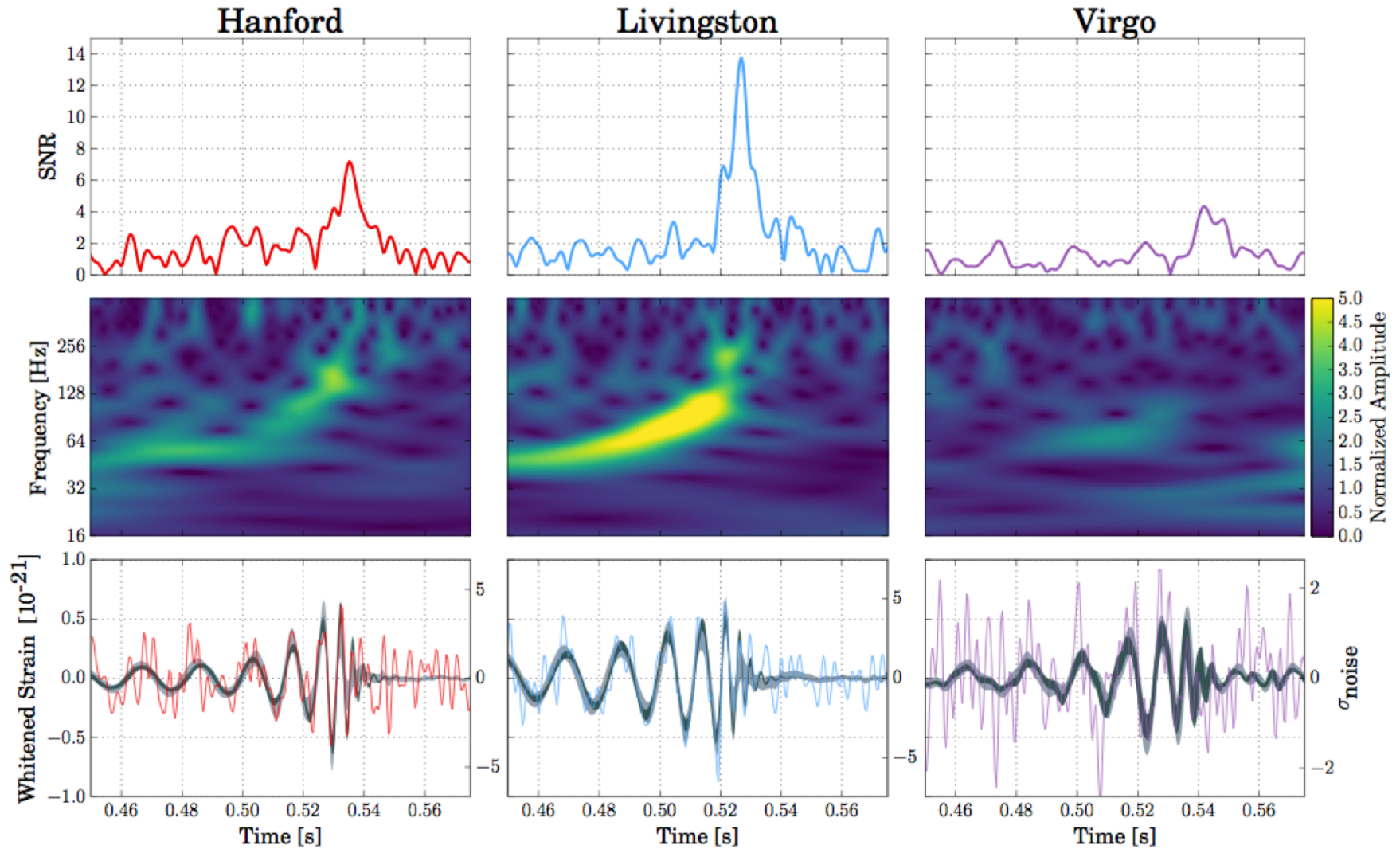

GW170814

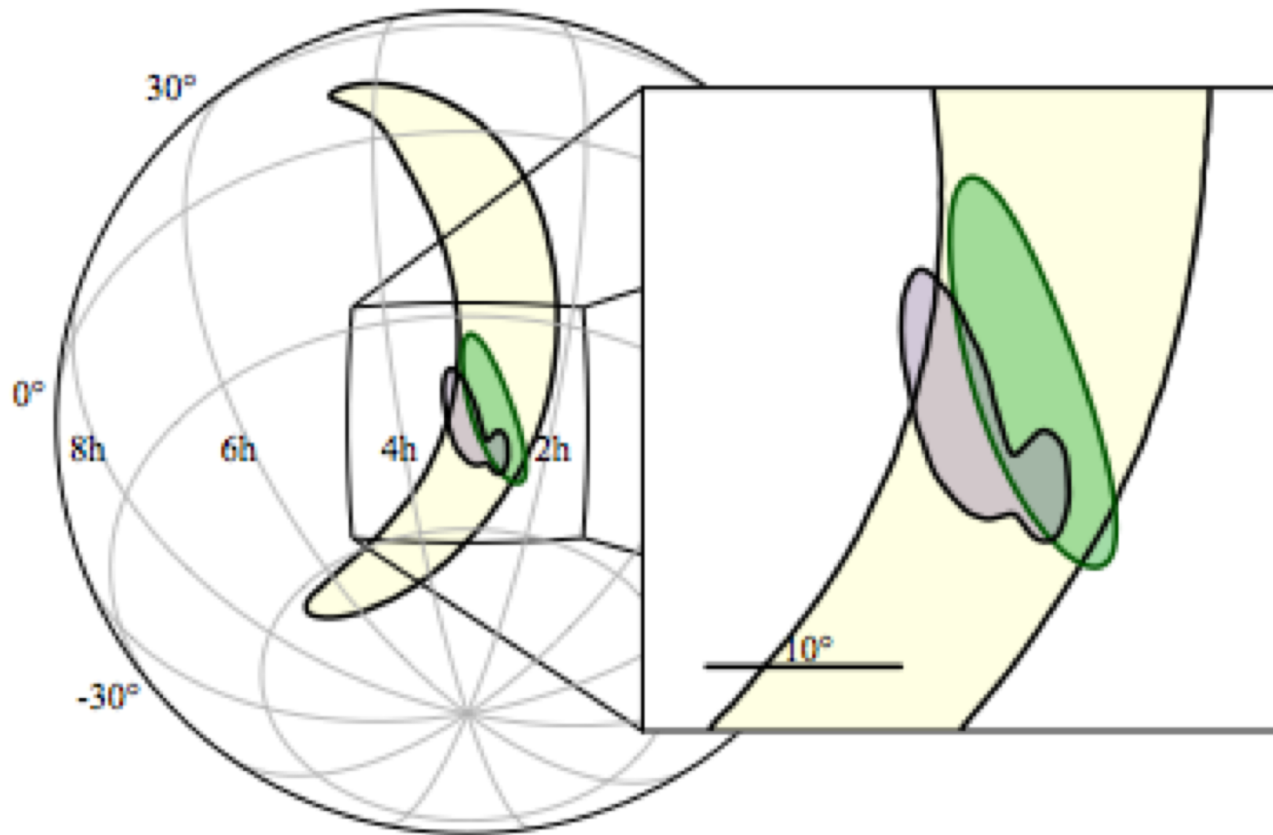

Sky localization improves $\sim 20x$

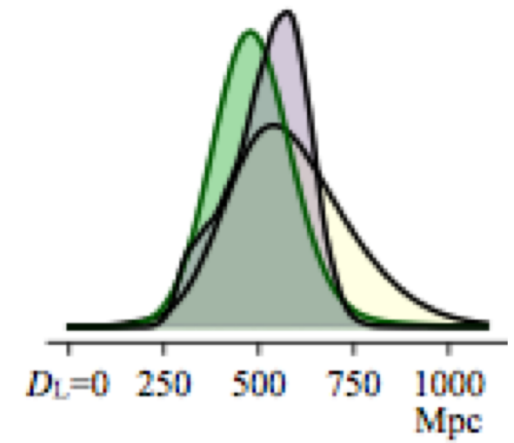

Uncertainty in volume reduced $\sim 34x$



GW170814

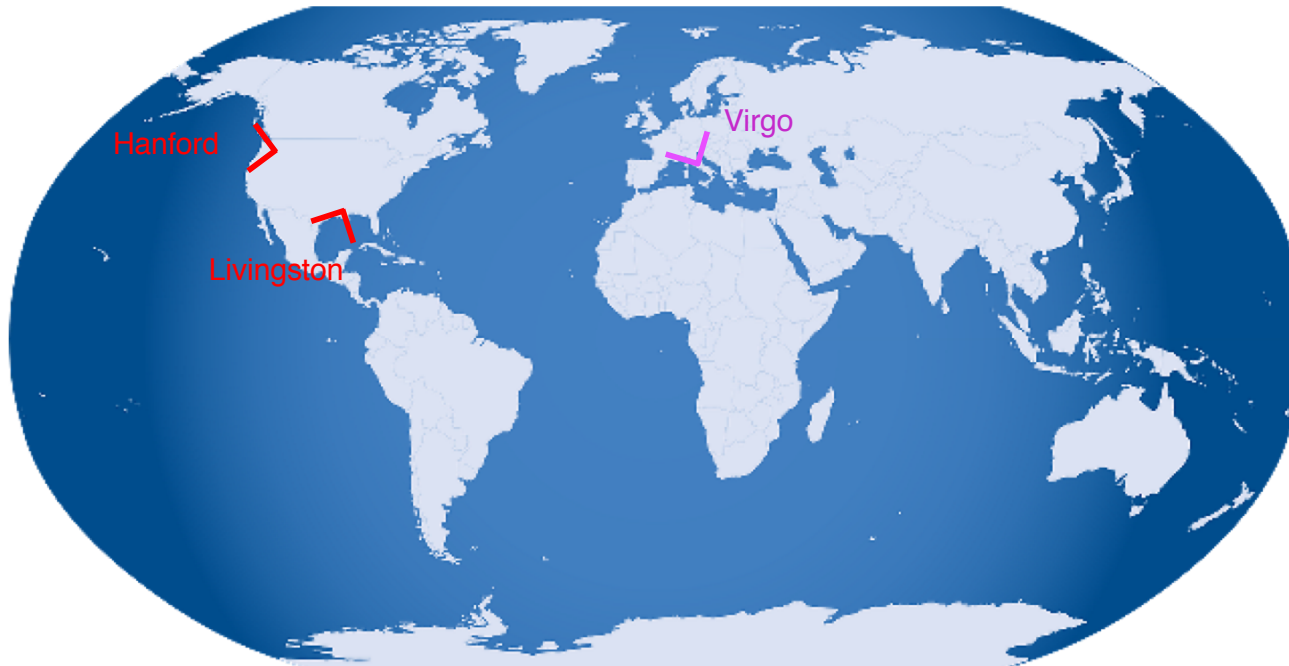

LIGO-Hanford and Livingston have similar orientations -> little information about GW polarizations

Virgo is not aligned with LIGO – giving polarization information

For GW170817, purely tensor polarization is strongly favored over purely scalar or vector polarizations – consistent with General Relativity



GW170817

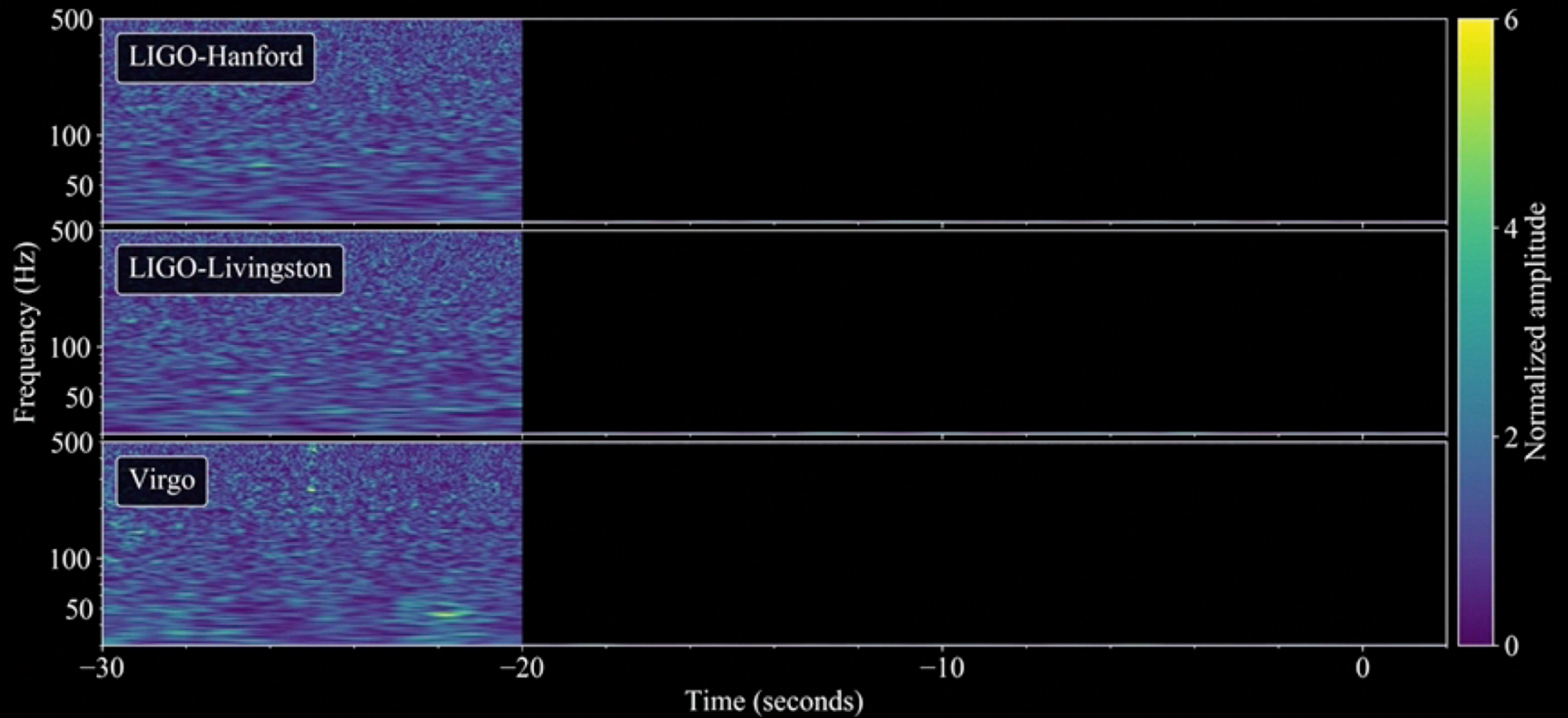

LIGO-Virgo/Geoffrey Lovelace, Duncan Brown, Duncan Macleod, Jessica McIver, Alex Nitz

Antenna pattern for a single detector

- Maximal for overhead or underfoot source
- $1/2$ for signals along one arm
- ...and zero at 45 degrees
- GW170817 fell on Virgo close to 45 degrees!
- Did no harm for localization. (GW170814 had proved the detector was working, happily)

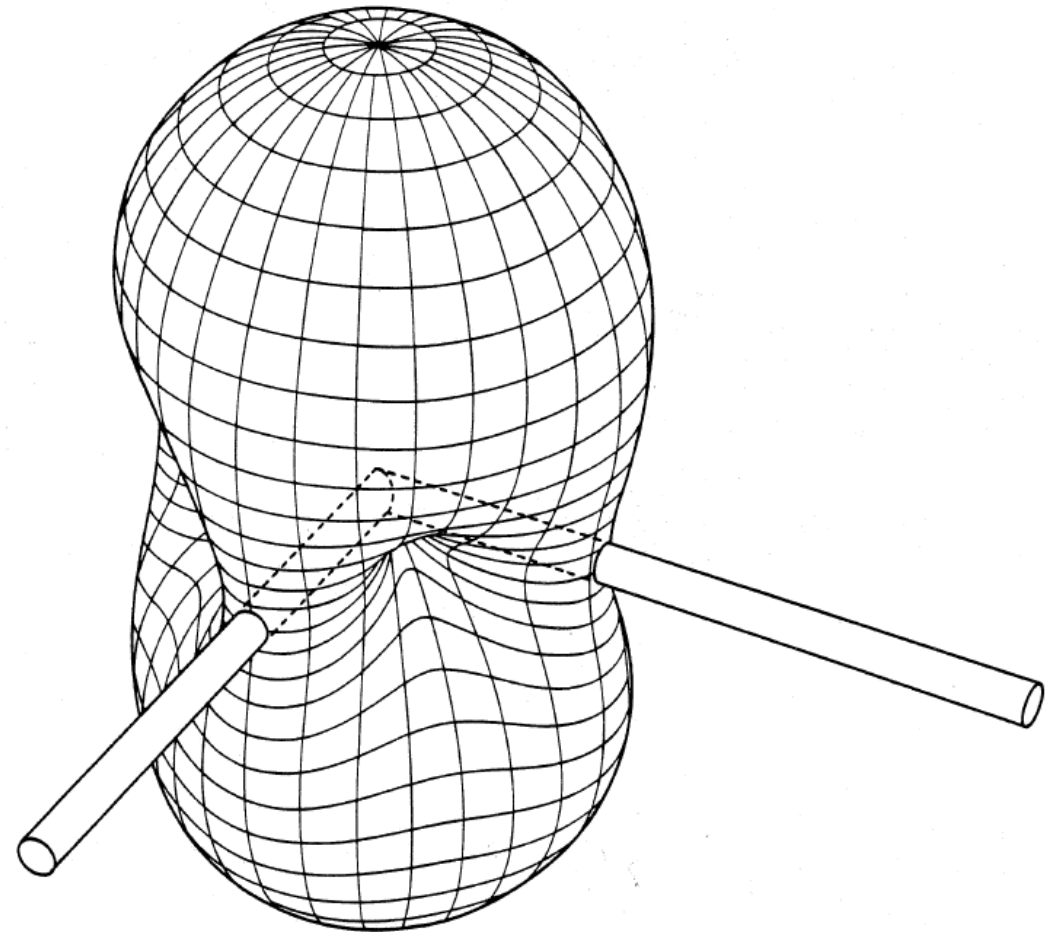



GRB 170817A

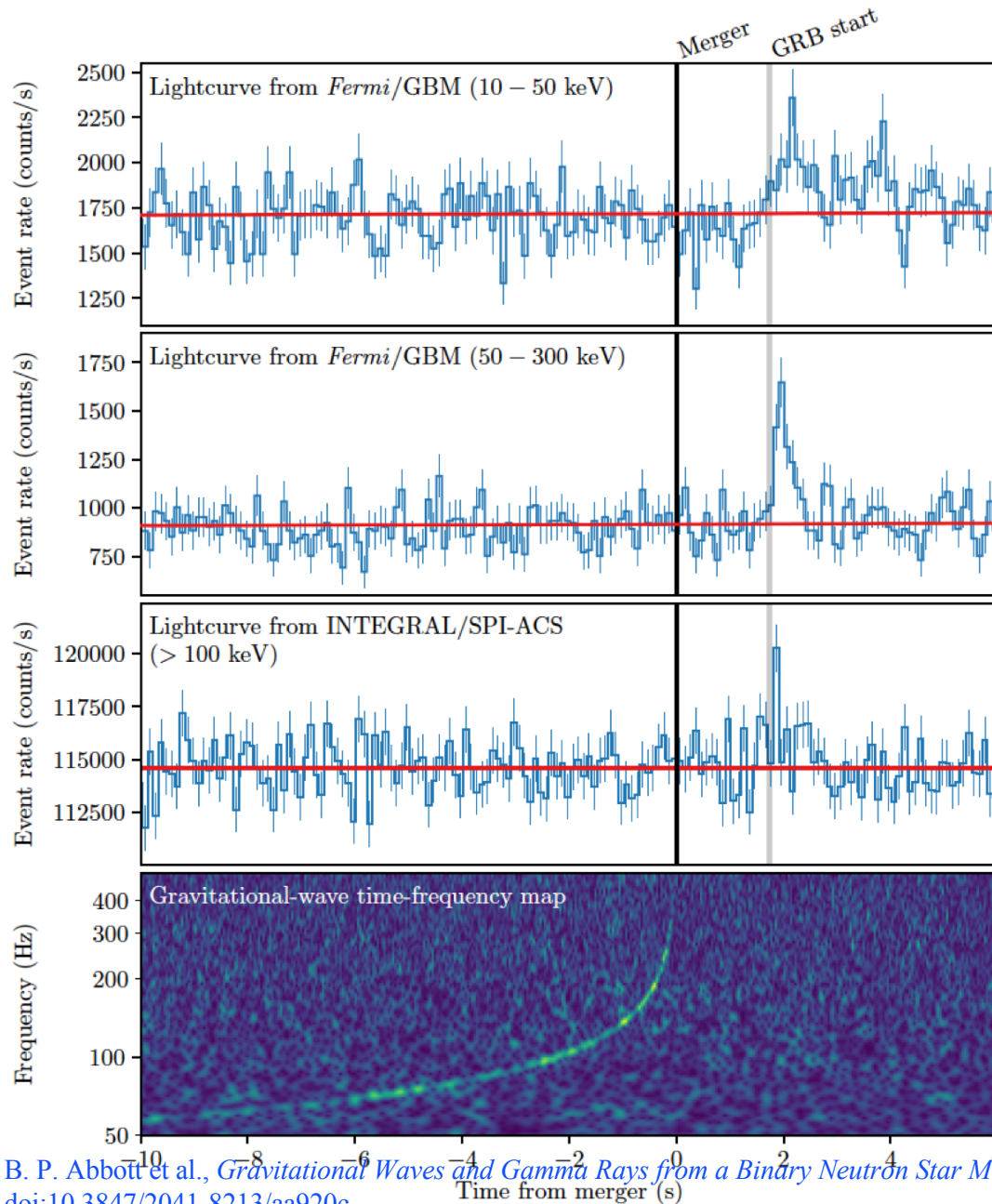

GRB 170817A occurs (1.74 ± 0.05) seconds after GW170817

It was autonomously detected in-orbit by *Fermi*-GBM (GCN was issued 14s after GRB) and in the routine untargeted search for short transients by INTEGRAL SPI-ACS

Probability that GW170817 and GRB 170817A occurred this close in time and with location agreement by chance is 5.0×10^{-8} (Gaussian equivalent significance of 5.3σ)

BNS mergers are progenitors of (at least some) SGRBs





Multimessenger Observations

Approximate timeline:

GW170817 - August 17,
2017 12:41:04 UTC = t_0

GRB 170817A
 $t_0 + 2$ sec

LIGO signal found
 $t_0 + 6$ minutes

LIGO-Virgo GCN reporting
BNS signal associated
with the time of the GRB
 $t_0 + 41$ minutes

SkyMap from LIGO-Virgo
 $t_0 + 4$ hours

Optical counterpart found
 $t_0 + 11$ hours

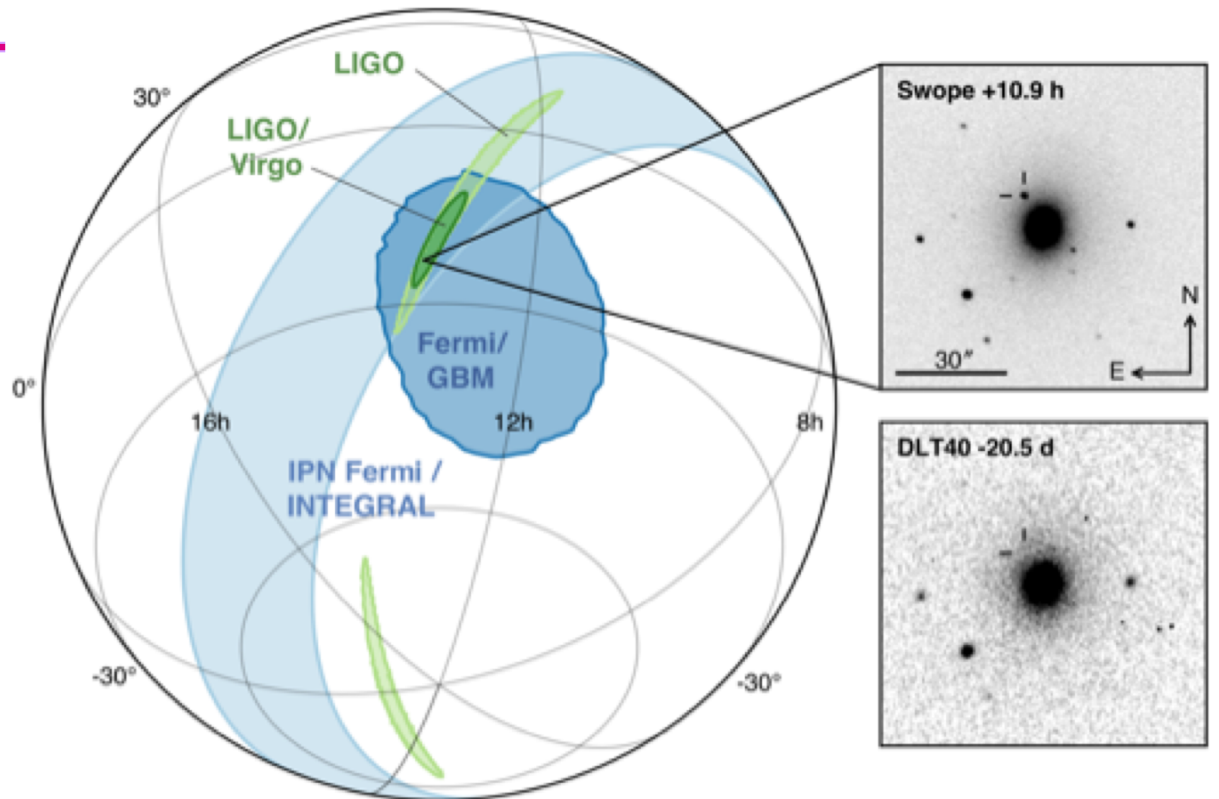

- The localisation region became observable to telescopes in Chile 10 hours after the event time (wait for nightfall!)
- Approximately 70 ground- and space- based observatories followed-up on this event

BNS properties

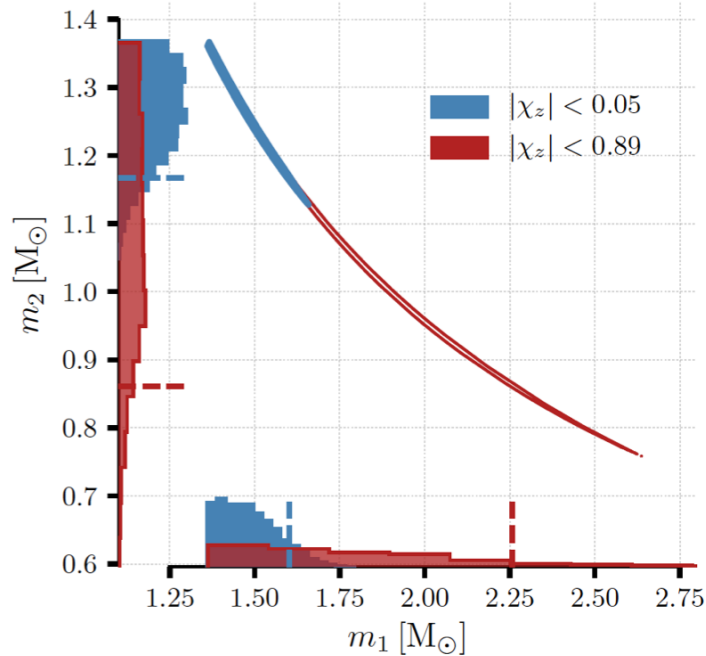

Sum of NS masses tightly constrained, individual masses less so

- $|\chi| \leq 0.89$ limit imposed by available rapid waveform models
- $|\chi| \leq 0.05$ limit consistent with the observed population of BNS

	Low-spin priors ($ \chi \leq 0.05$)
Primary mass m_1	$1.36 - 1.60 M_\odot$
Secondary mass m_2	$1.17 - 1.36 M_\odot$
Chirp mass \mathcal{M}	$1.188^{+0.004}_{-0.002} M_\odot$
Mass ratio m_2/m_1	$0.7 - 1.0$
Total mass m_{tot}	$2.74^{+0.04}_{-0.01} M_\odot$
Radiated energy E_{rad}	$> 0.025 M_\odot c^2$

Neutron star equation-of-state

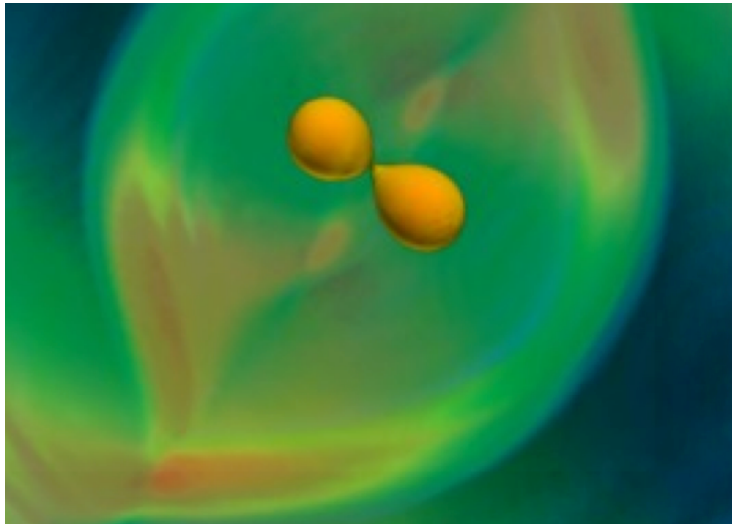

- Tidal disruption is encoded in the BNS gravitational waveform
- For this event, mostly masked by high-frequency noise in detector
- Some constraints possible

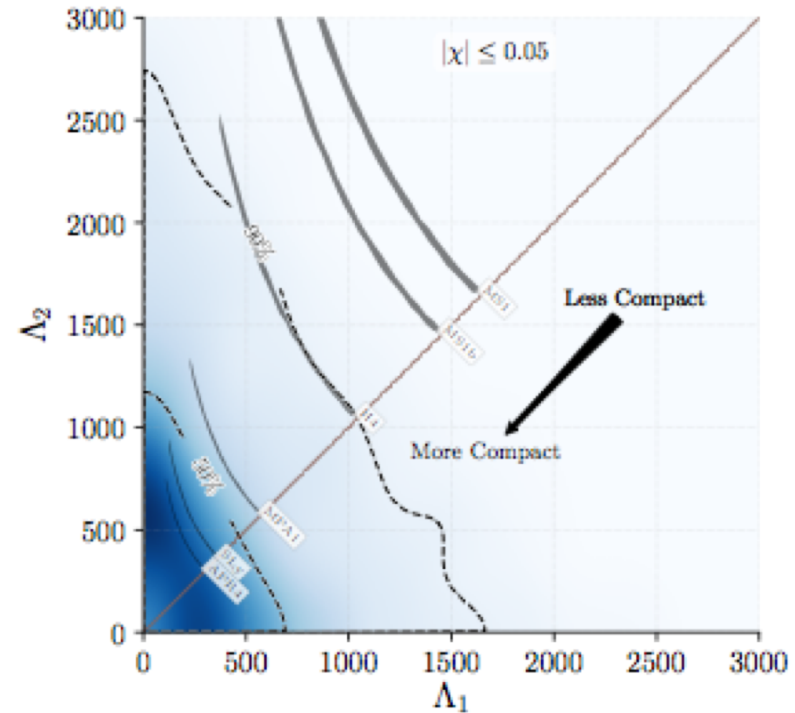

tidal deformability parameter $\Lambda \sim k_2 (R/m)^5$

k_2 - second Love number

R, m = radius, mass of the neutron star

GW170817: Observation of Gravitational Waves from a Binary Neutron Star Inspiral

Phys. Rev. Lett., 119:161101, 2017



GWs as standard sirens: Hubble Constant

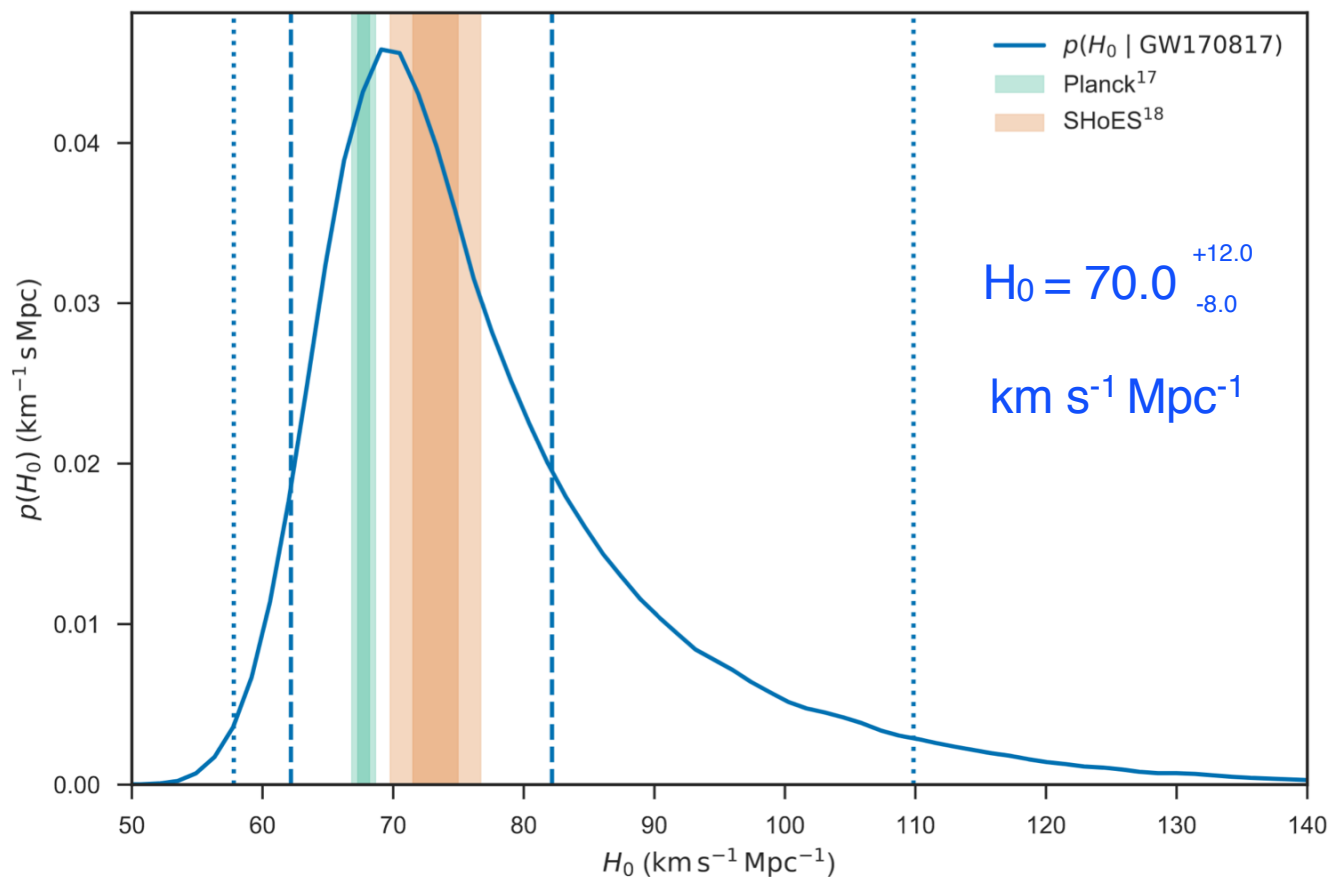

v_H - local “Hubble flow” velocity of
the source

Use optical identification of the
host galaxy NGC 4993

$$v_H = H_0 d$$

d - distance to the source
Use the GW distance estimate

Multi-messenger Astronomy



Gravitational Waves



Visible/Infrared Light

Binary Neutron Star Merger

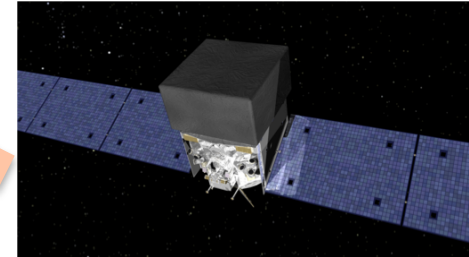
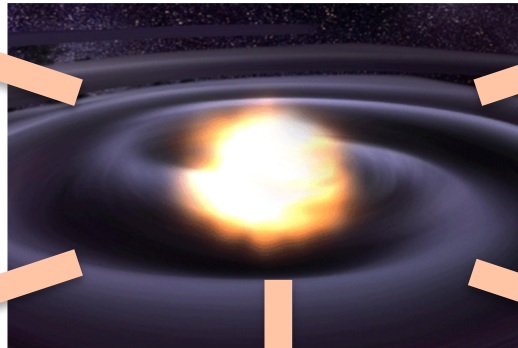

X-rays/Gamma-rays

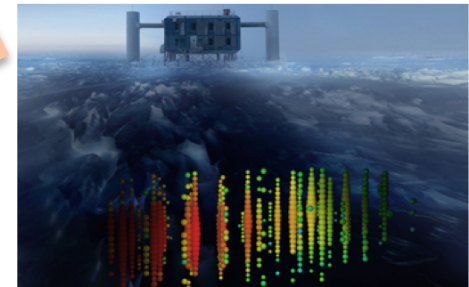

Neutrinos

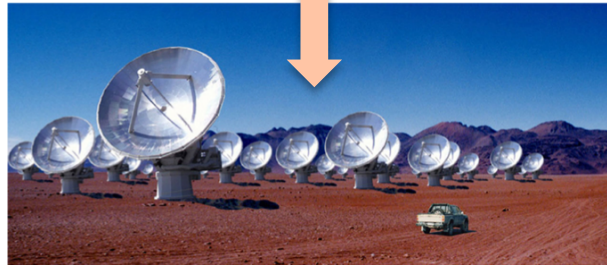

Radio Waves

LIGO and Virgo signed agreements with 95 groups for EM/neutrino followup of GW events

- ~200 EM instruments - satellites and ground based telescopes covering the full spectrum from radio to very high-energy gamma-rays
- Worldwide astronomical institutions, agencies and large/small teams of astronomers

Events in the detector response context

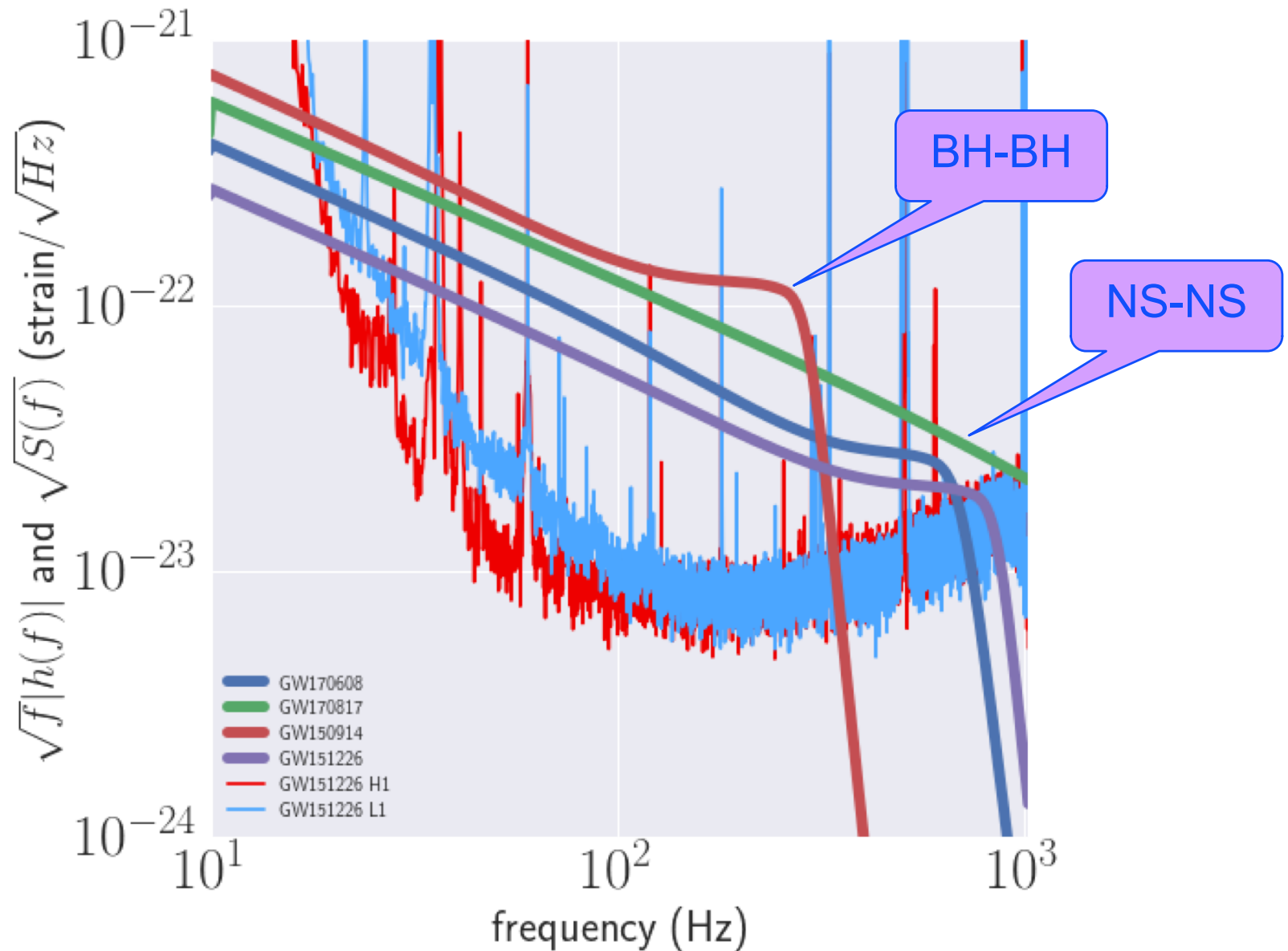



Masses in the Stellar Graveyard

in Solar Masses

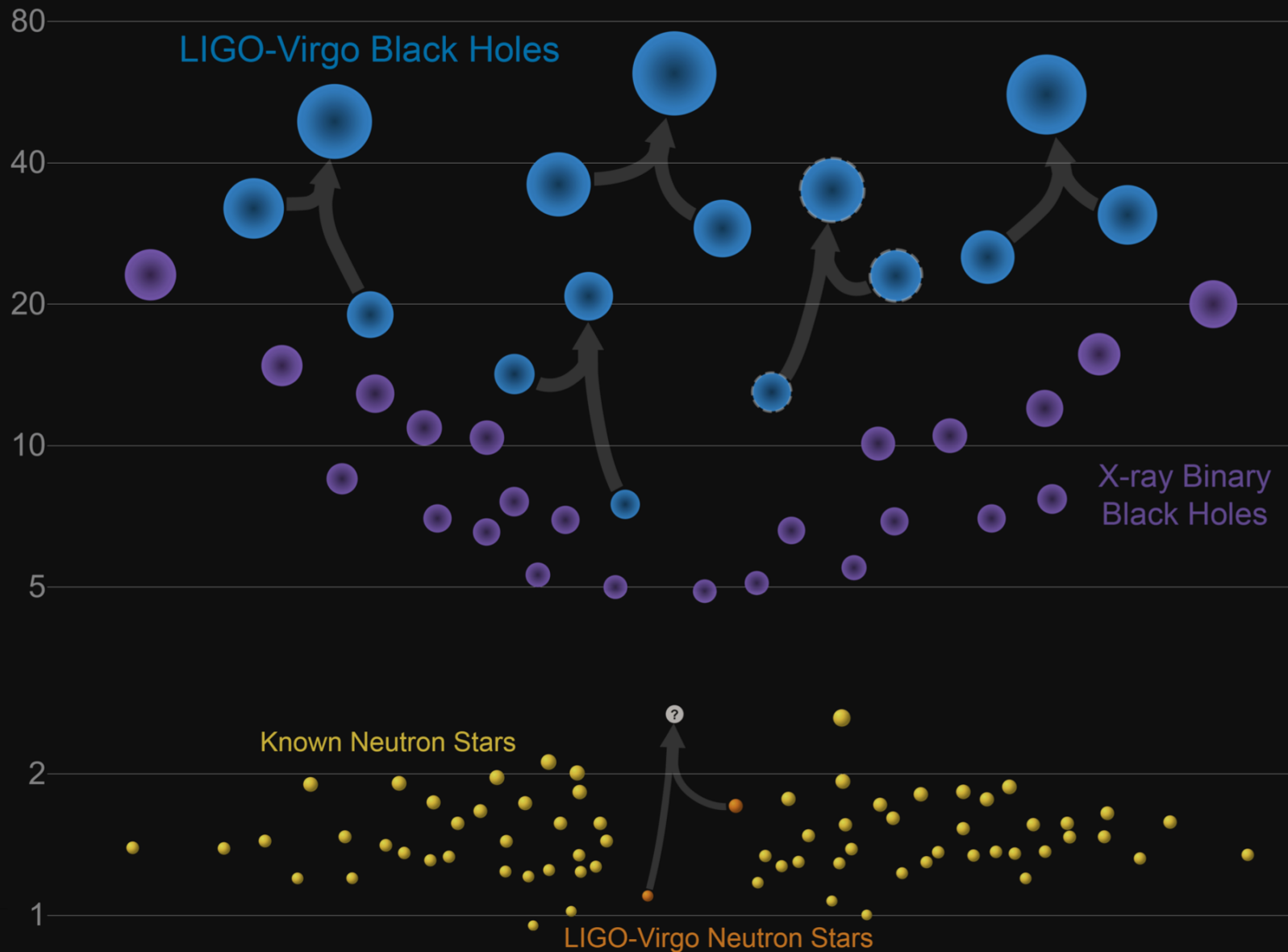



Rates of compact object mergers

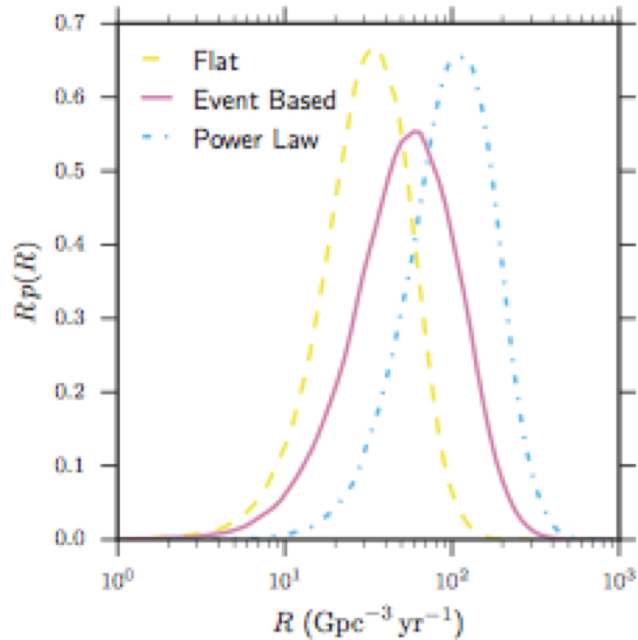

Binary Black Hole Merger Rate

- Based on O1 BBH mergers: $9\text{-}240 \text{ Gpc}^{-3} \text{ yr}^{-1}$
- Addition of GW170104, BBH merger rate: $12\text{-}213 \text{ Gpc}^{-3} \text{ yr}^{-1}$
- Observation of GW170814 consistent with this population

Binary Neutron Star Merger Rate

- Based on O1 non-detections: $< 12,600 \text{ Gpc}^{-3} \text{ yr}^{-1}$
- Based on GW170817: $320\text{-}4740 \text{ Gpc}^{-3} \text{ yr}^{-1}$

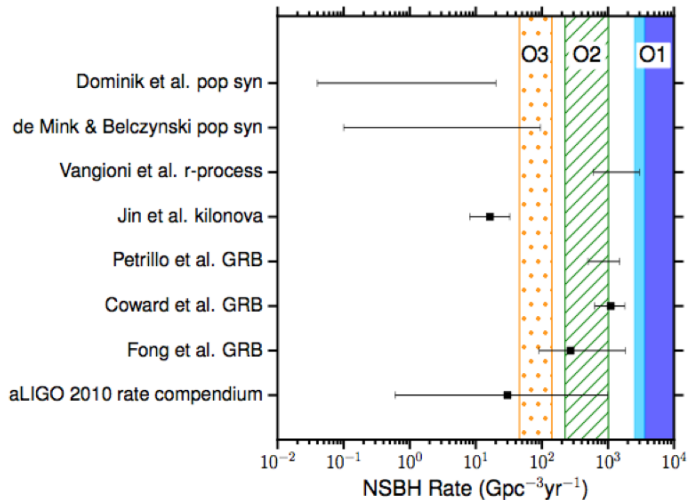

Neutron Star - Black Hole Merger Rate

- Based on O1 non-detections (black hole mass at least $5 M_{\odot}$): $< 3,600 \text{ Gpc}^{-3} \text{ yr}^{-1}$

B. P. Abbott et al., *Binary Black Hole Mergers in the First Advanced LIGO Observing Run, 2016*, Phys. Rev. X 6, 041015

B. P. Abbott et al., *GW170401: Observation of a 50-Solar-Mass Binary Black Hole Coalescence at Redshift 0.2*, 2017, Phys. Rev. Lett., 118, 221101

B. P. Abbott et al., *Upper limits on the rates of binary neutron star and neutron-star-black-hole mergers from Advanced LIGO's first observing run*, 2016, [arXiv:1606.04868](https://arxiv.org/abs/1606.04868)



Work continues on analyzing O2...

- The output of the detector is the (signed) strain as a function of time
- Earlier measurements of the pulsar period decay (Taylor/Hulse/Weisberg) measured energy loss from the binary system – a beautiful experiment
 - radiation of gravitational waves confirmed to *remarkable* precision for 0th post-Newtonian
- **LIGO can actually measure the change in distance between our own test masses, due to a passing space-time ripple**
 - Instantaneous amplitude rather than time-averaged power
 - Much richer information!



Still analyzing O2 Data

- 'Cleaning' the data – regressing out couplings to noise sources
- Looking for lower-significance events
- Looking for other kinds of signals
 - » 'Bursts' – SN, cosmic strings, unexpected
 - » Continuous Waves from pulsars
 - » Stochastic background, most likely from Astrophysical sources...but have our eye on limits to the primordial background

- ...Stay Tuned!



Plausible Observing Timeline

Binary Neutron Star Range

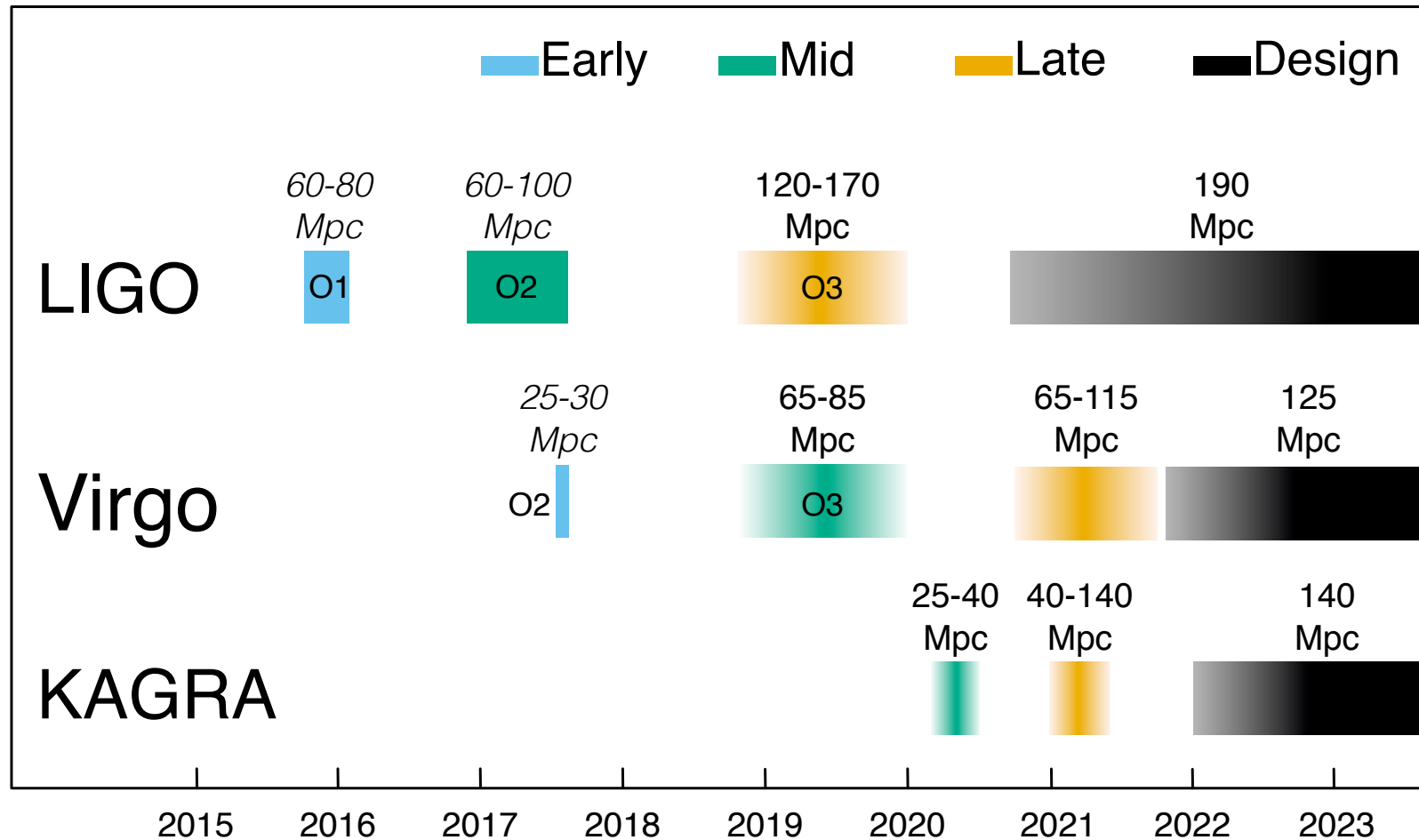

B. P. Abbott et al., *Prospects for Observing and Localizing Gravitational-Wave Transients with Advanced LIGO, Advanced Virgo and KAGRA*, 2016, Living Rev. Relativity 19



LIGO Scientific Collaboration and Virgo Collaboration



~1500 members, ~120 institutions, 21 countries



What does the future hold?

The advanced GW detector network

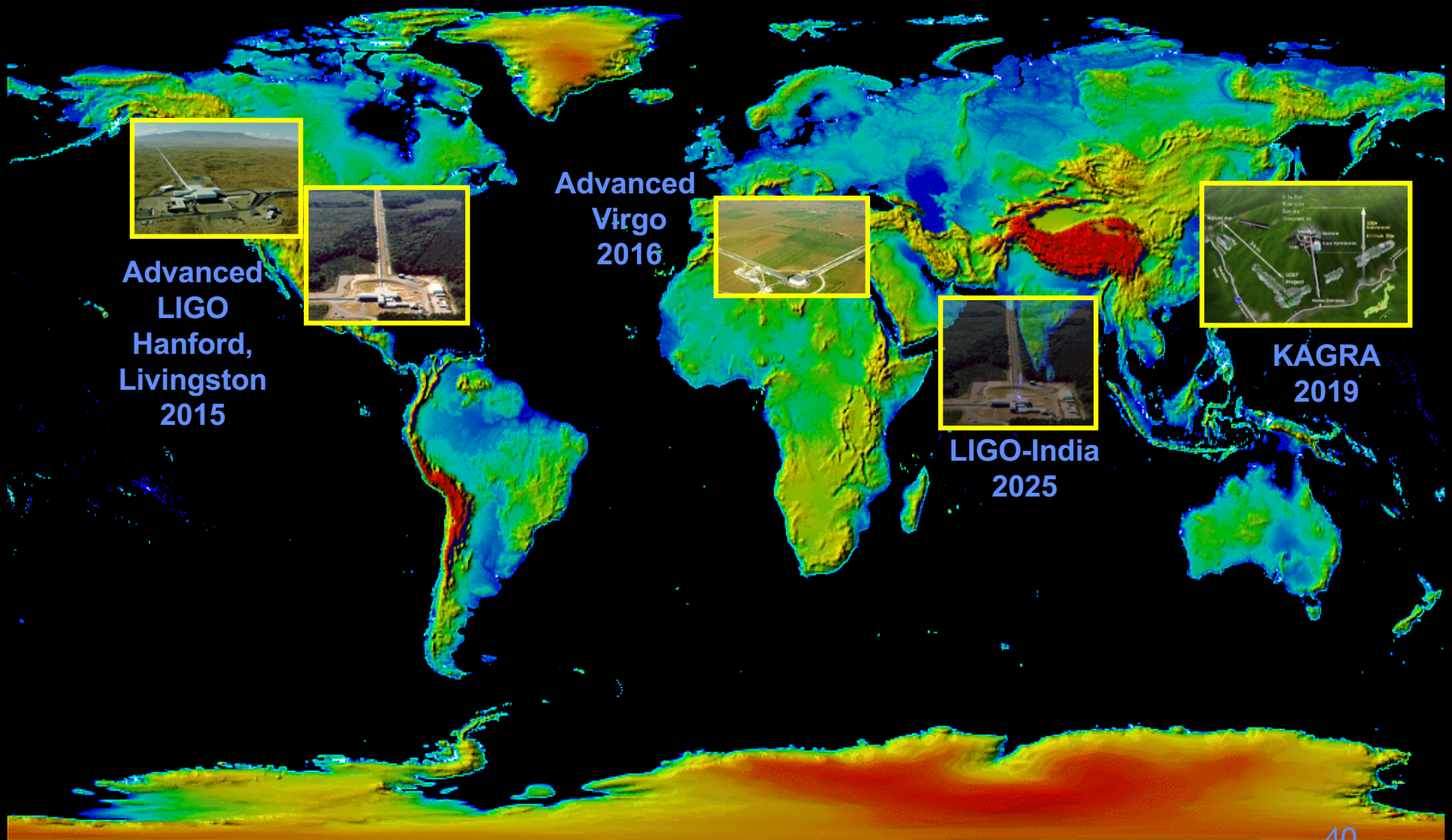



First Detection Sensitivity/configuration:

2 detectors, 1/3 goal sensitivity -- saw ~3+ signals in ~6 months of observation

GW150914
GW151226
LVT151012

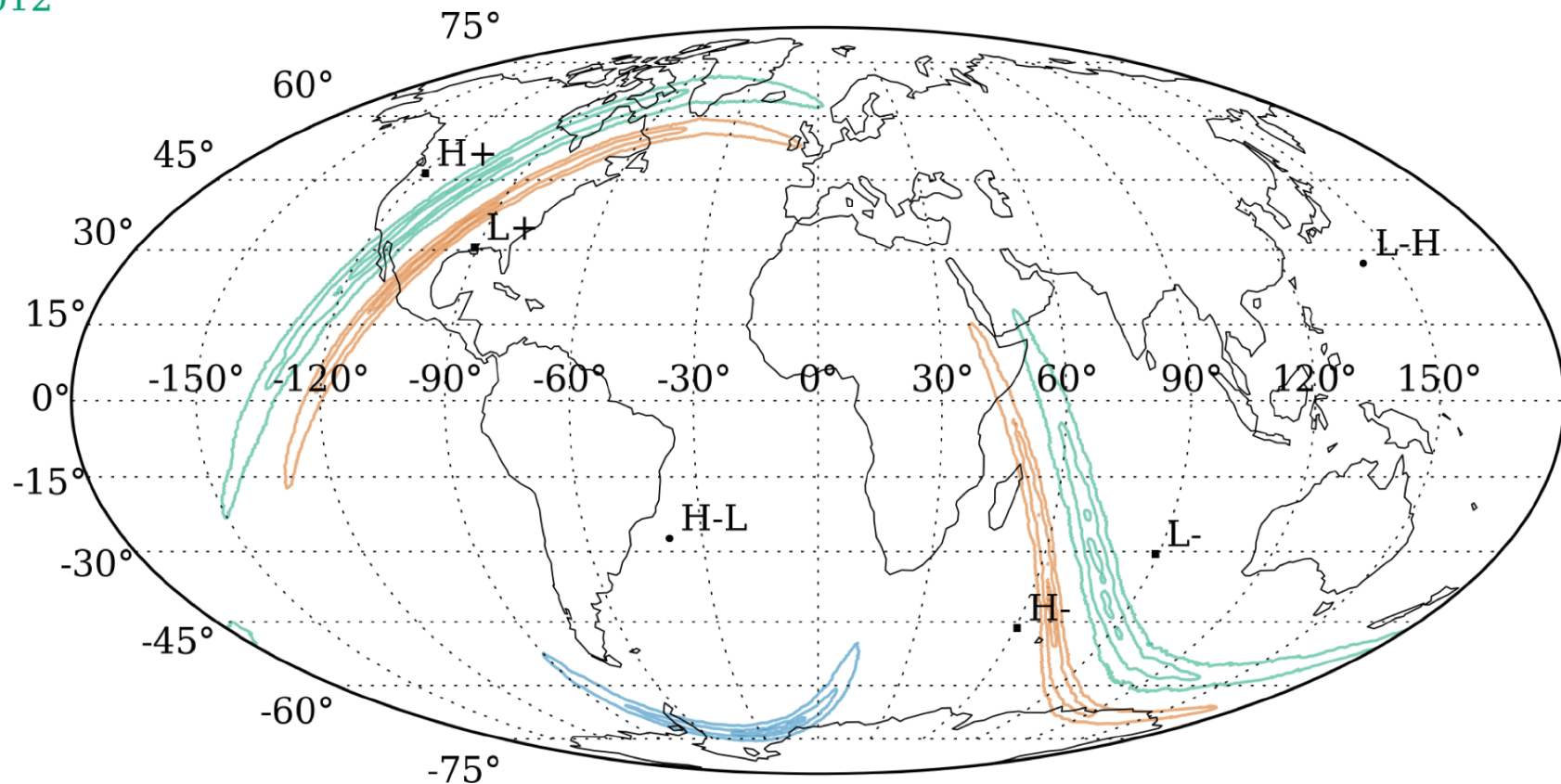



2017 Sensitivity/configuration:

3 detectors (adding Virgo), see
~1 signal per month of observation
GW170817 marked with ★

<10% in 20 sq deg

HLV 2016-2017

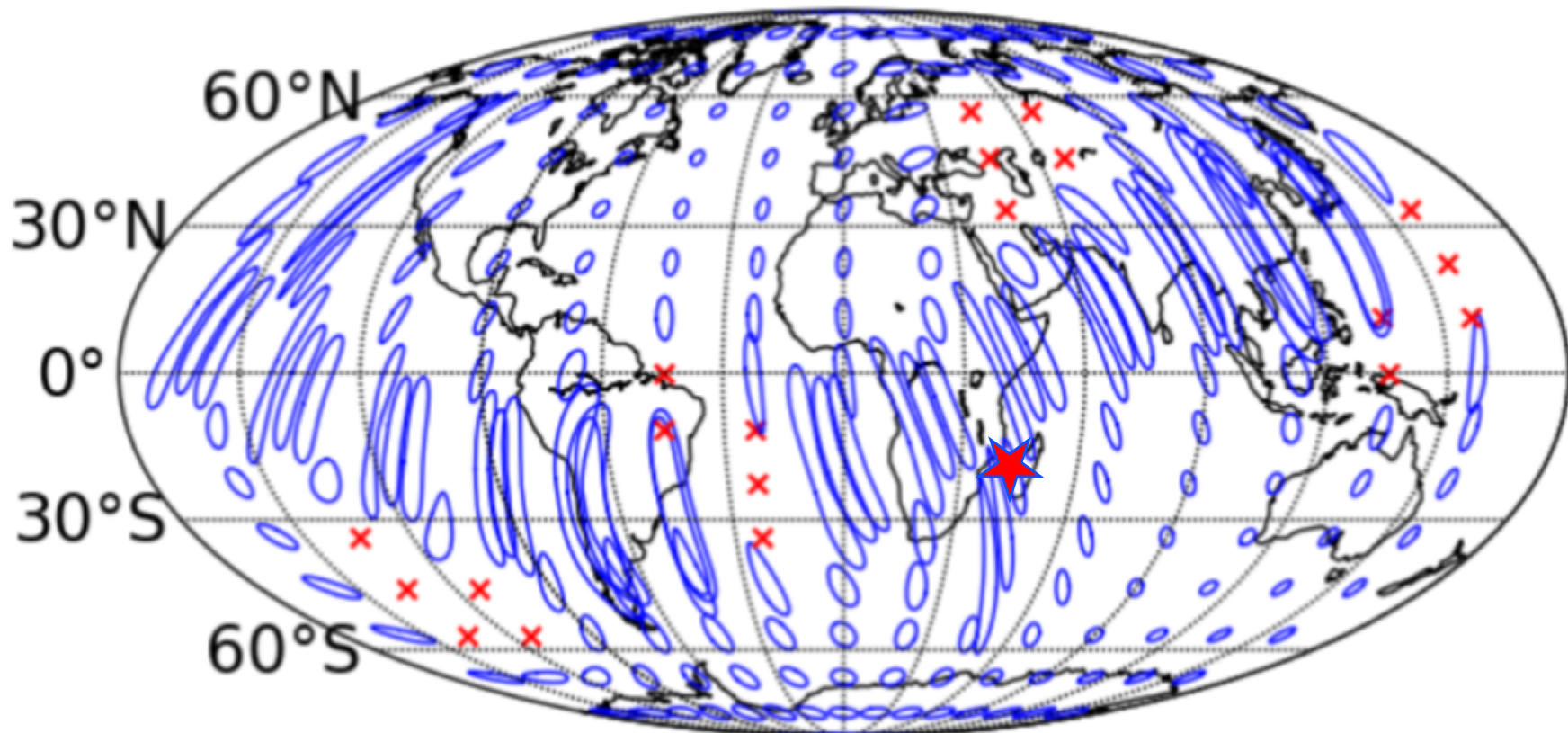



2018-19 Sensitivity/configuration:

3 detectors, perhaps
~1-2 signals *per week*

~20% in 20 sq deg

HLV 2019

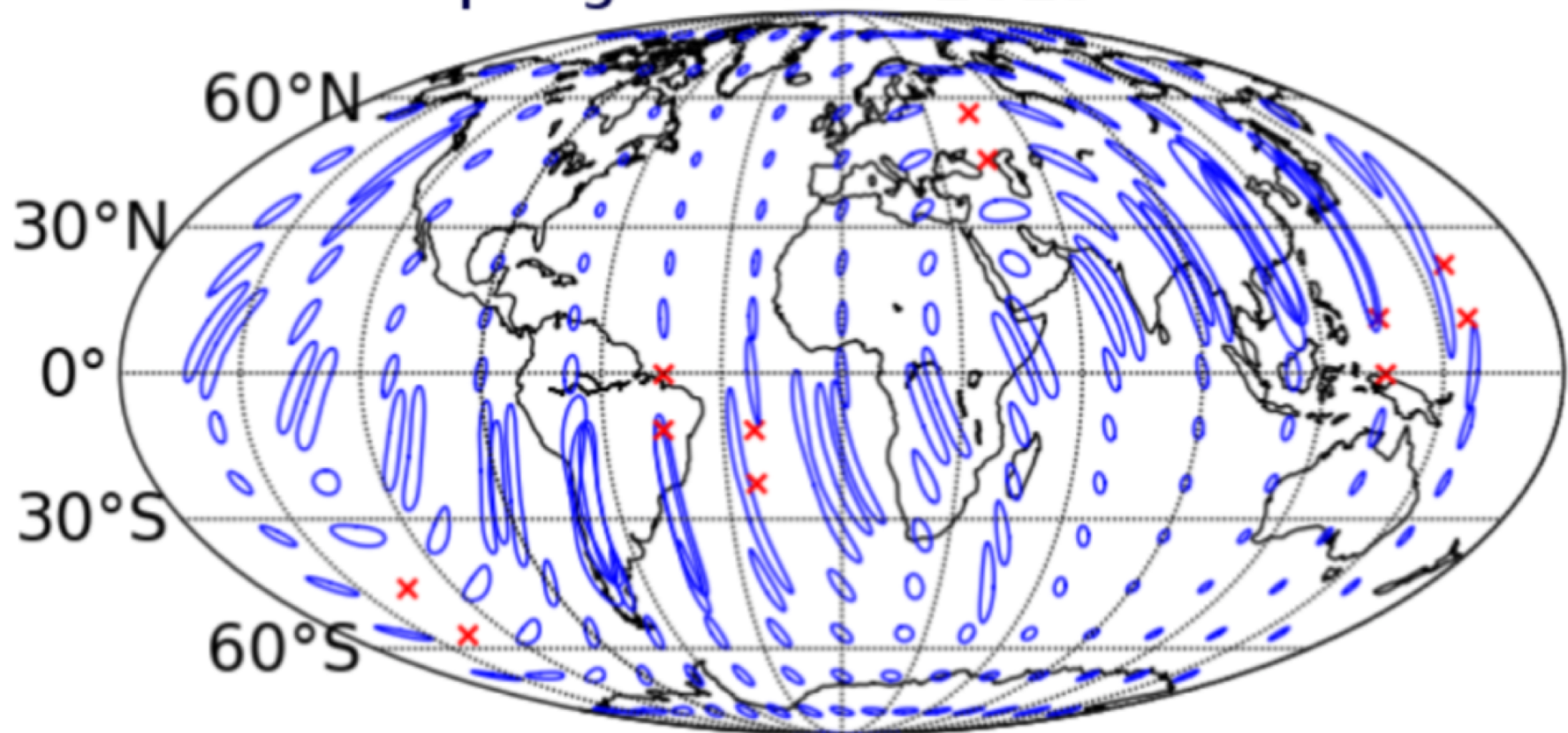



2024 Sensitivity/configuration:

5 detectors (add India and Japan)
far improved source localization

~60% in 10 sq deg

HIKLV

2024

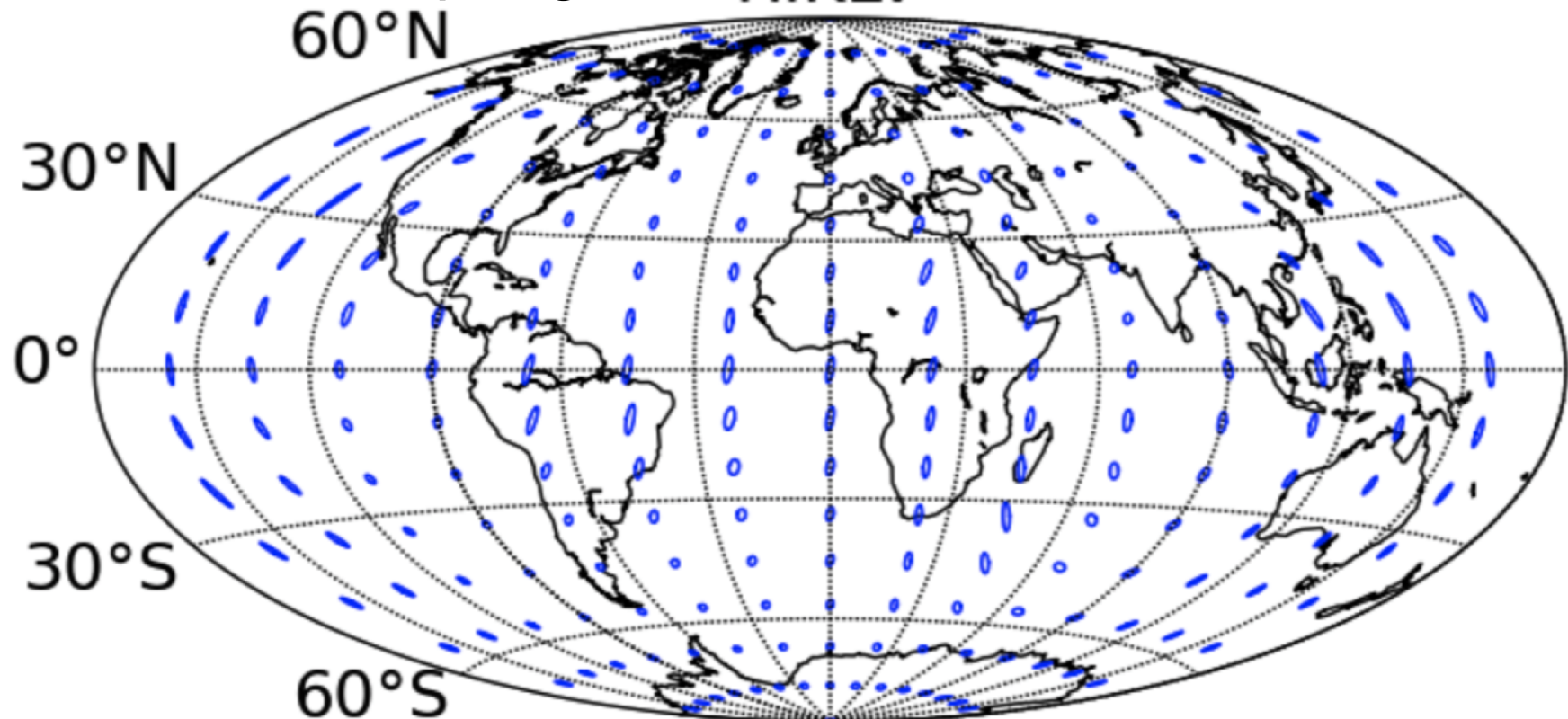

Evolution of detectors

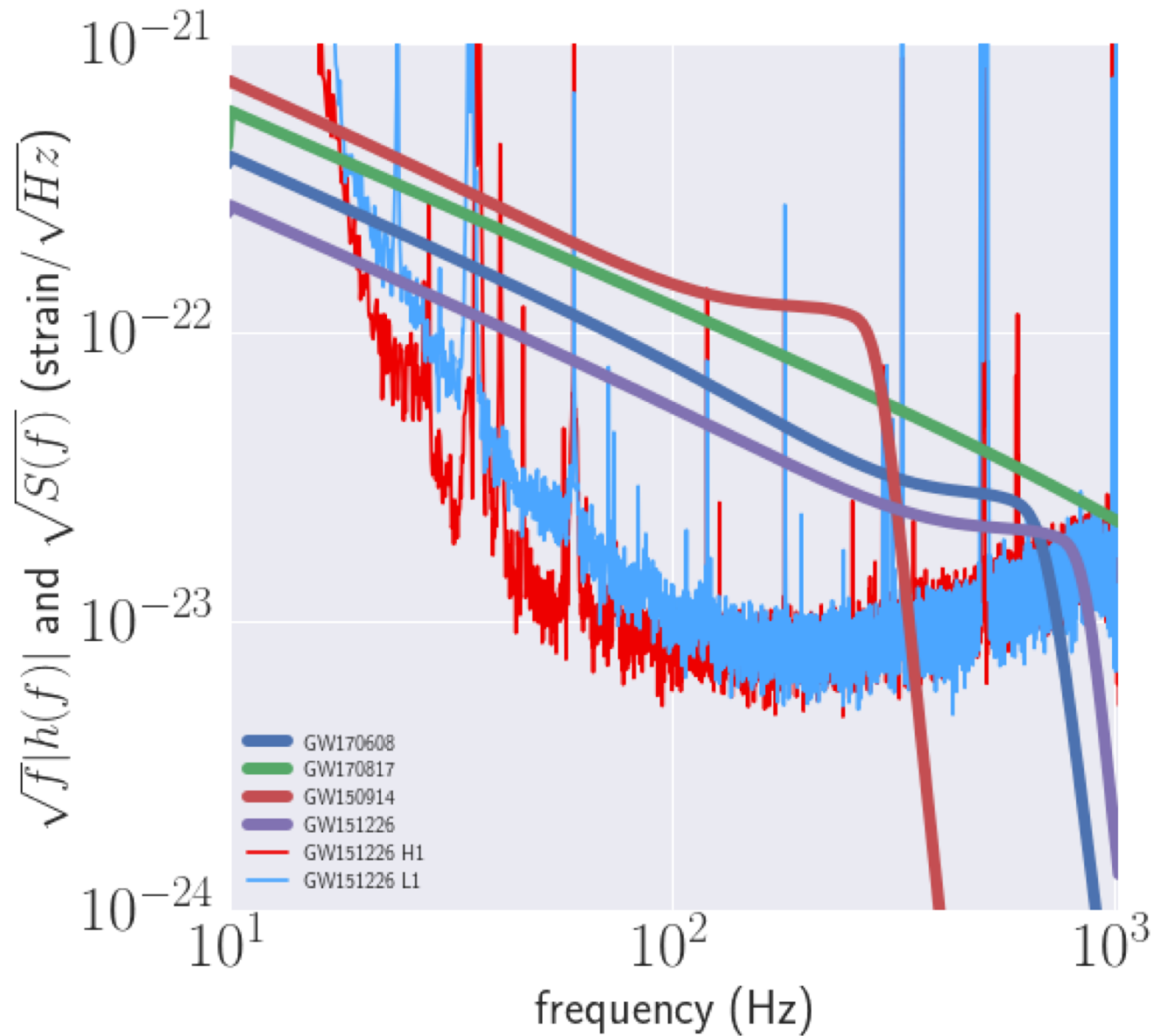

Evolution of detectors

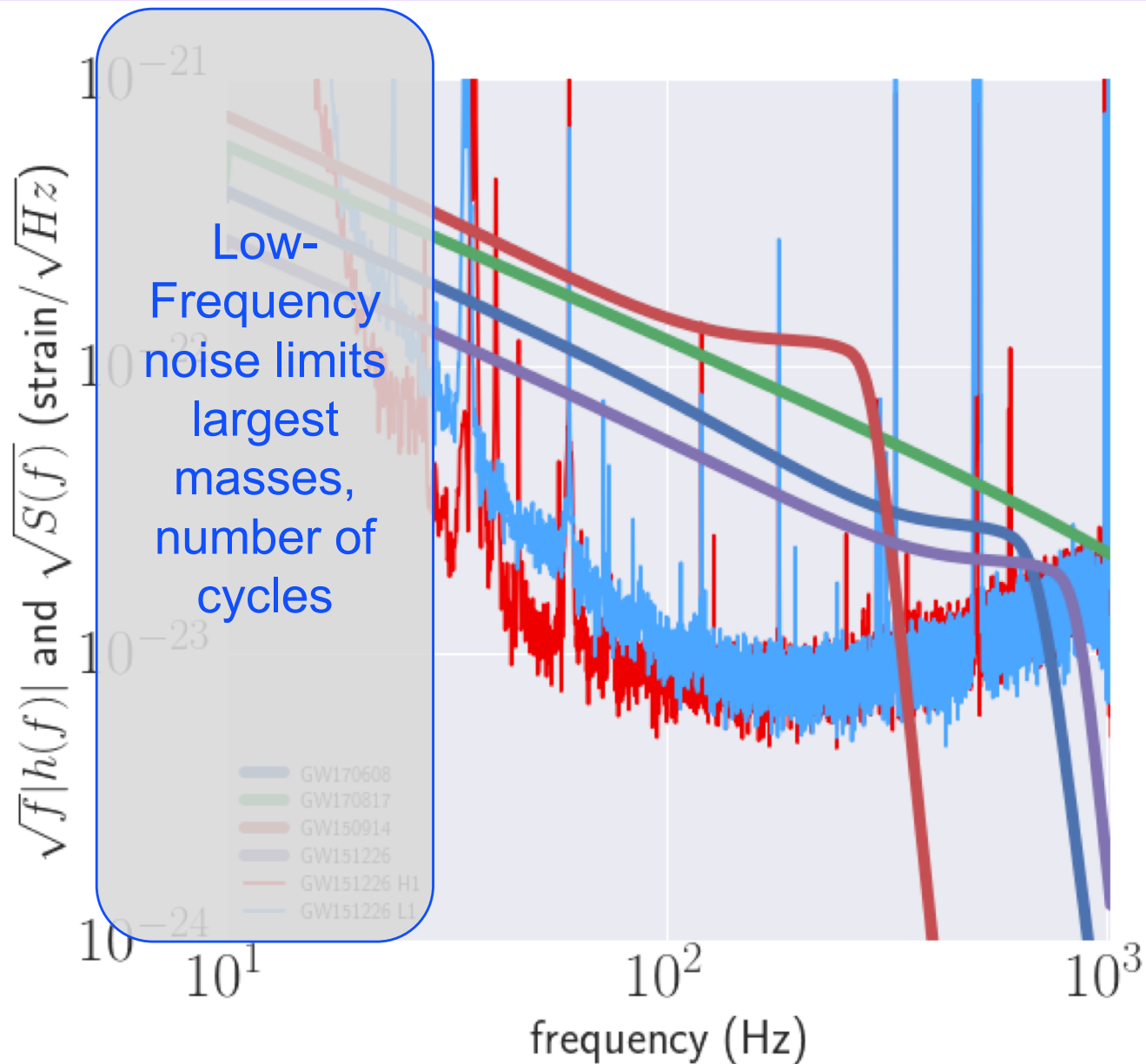

Evolution of detectors

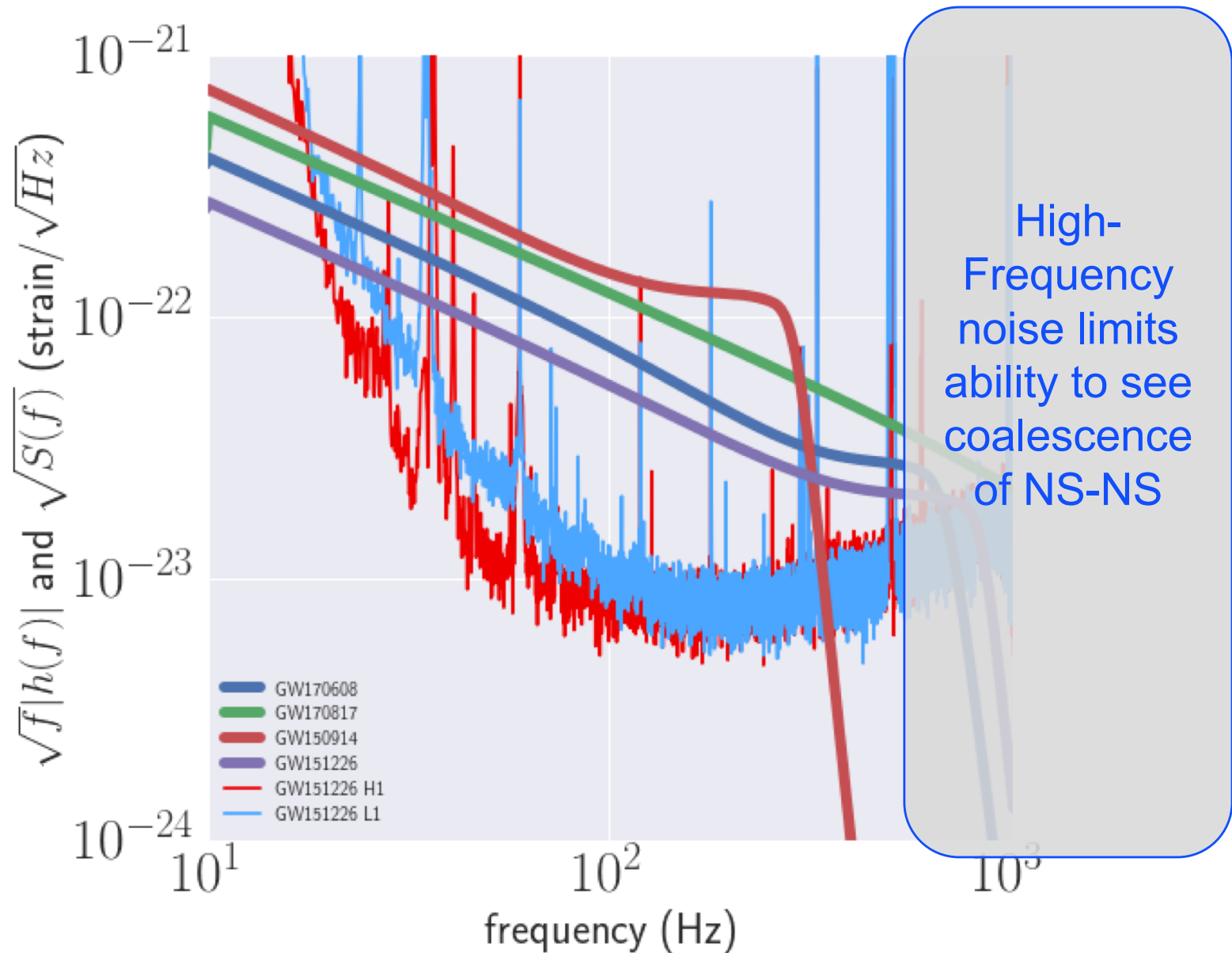

Evolution of detectors

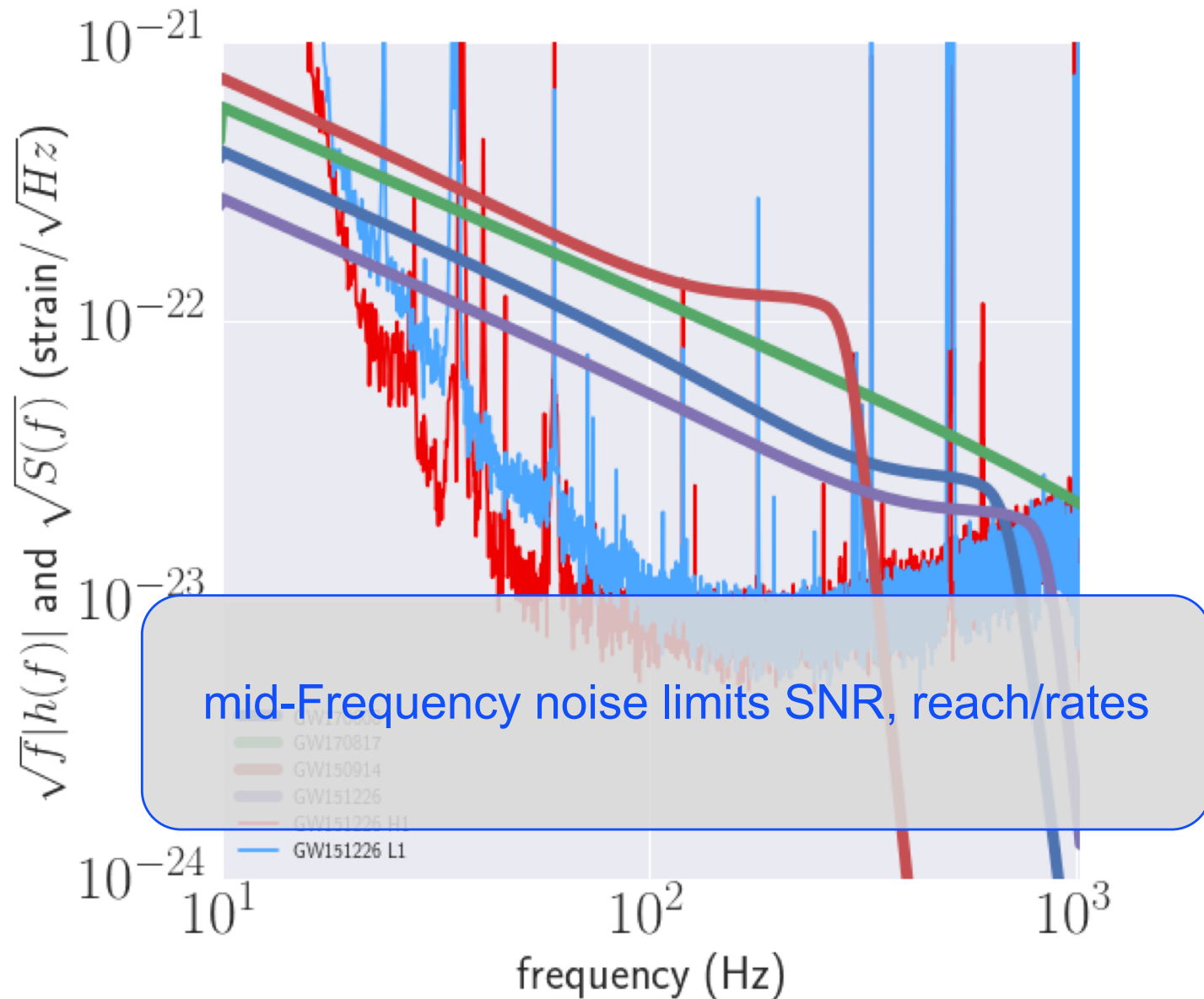

Evolution of detectors

- aLIGO, AdV – commission to full sensitivity by early 2020's
- A+, AdV+ – add squeezing, lower thermal noise coatings; ~2024
- Voyager – cryogenics to reduce thermal noise; ~2028
- ..at that point there is no choice but to seek longer arms

→ Einstein Telescope

→ Cosmic Explorer

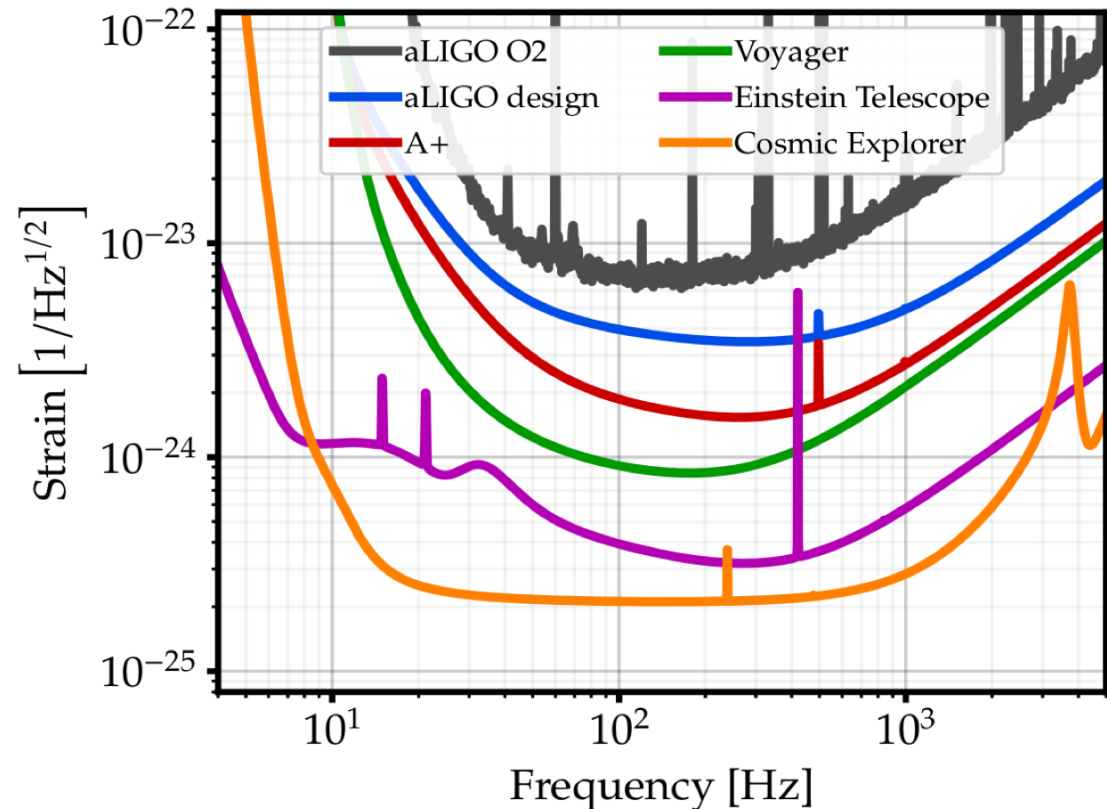



Further Future Improvements: The 3rd generation

- One Concept: Einstein Telescope
- Significant design study undertaken for both Facility and Instruments
- Underground construction proposed to reduce Newtonian Background
 - » (and be compatible with densely-populated Europe)
- Triangle – LISA-like –
with 10km arms
- Multiple instruments in a
'Xylophone' configuration
 - » Allows technical challenges
for low- and high-frequency
to be separated
- Designed to accommodate a
range of detector topologies and
mechanical realizations
 - » Including squeezing and
cryogenics

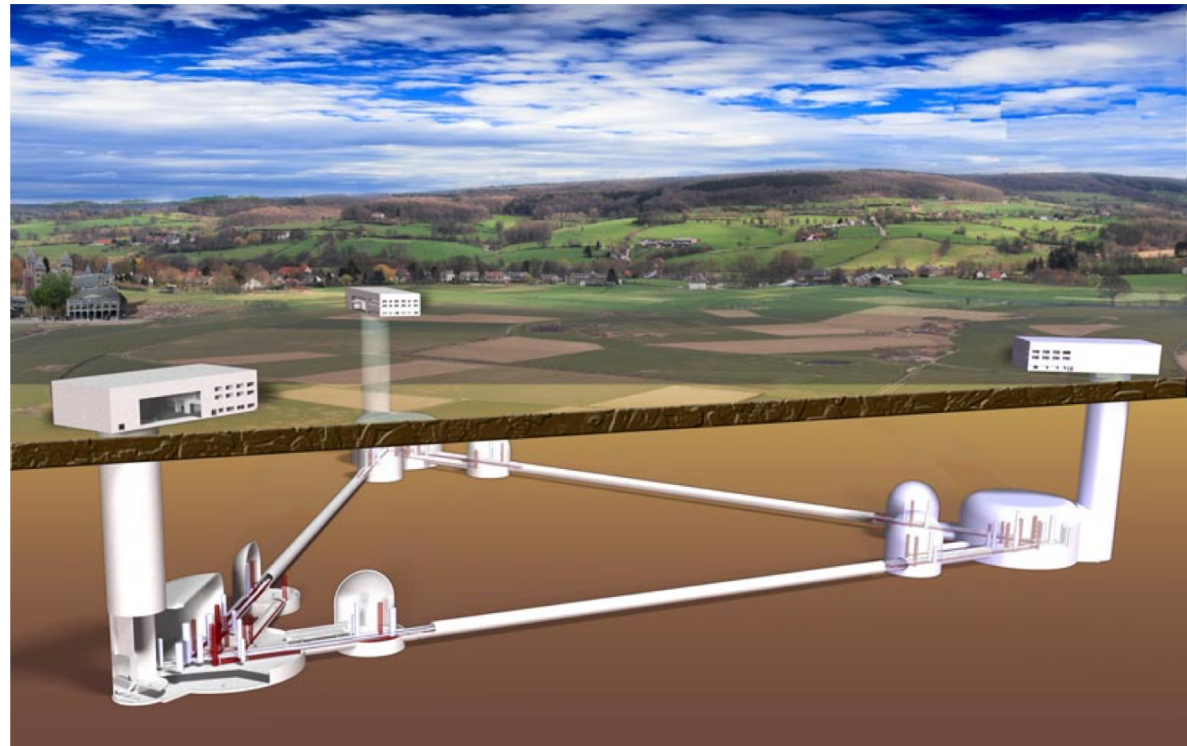



Another Concept: Make Advanced LIGO 10x longer, 10x more sensitive

Signal grows with length – **not** most noise sources

- Thermal noise, radiation pressure, seismic, Newtonian unchanged
- Coating thermal noise improves faster than linearly with length
- 40km surface Observatory ‘toy’ baseline
 - can still find sites, earthmoving feasible; costs another limit...
- Concept offers sensitivity without new measurement challenges; could start at room temperature, modest laser power, etc.

	Adv. LIGO	40 km LIGO
Arm length	4 km	40 km
Beam radius	6.2 cm	11.6 cm
Measured squeezing	none	5 dB
Filter cavity length	none	1 km
Suspension length	0.6 m	1 m
Signal recycling mirror trans.	20%	10%
Arm cavity circulating power	775 kW	
Arm cavity finesse	446	
Total light storage time	200 ms	2 s

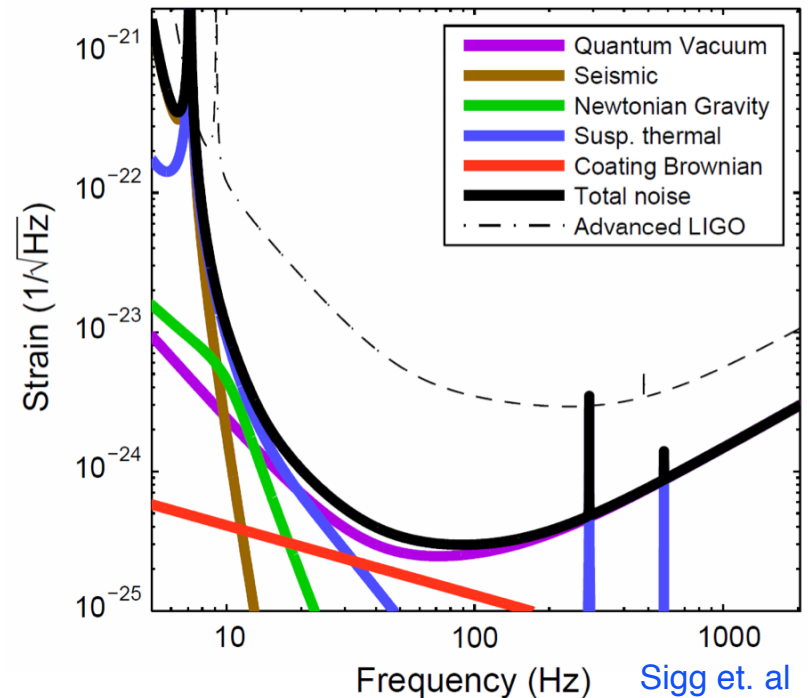



Einstein Telescope, Cosmic Explorer

'Green field' multi-generation Observatories ~G\$/G€

Horizon and 10, 50 and 75 % confidence levels

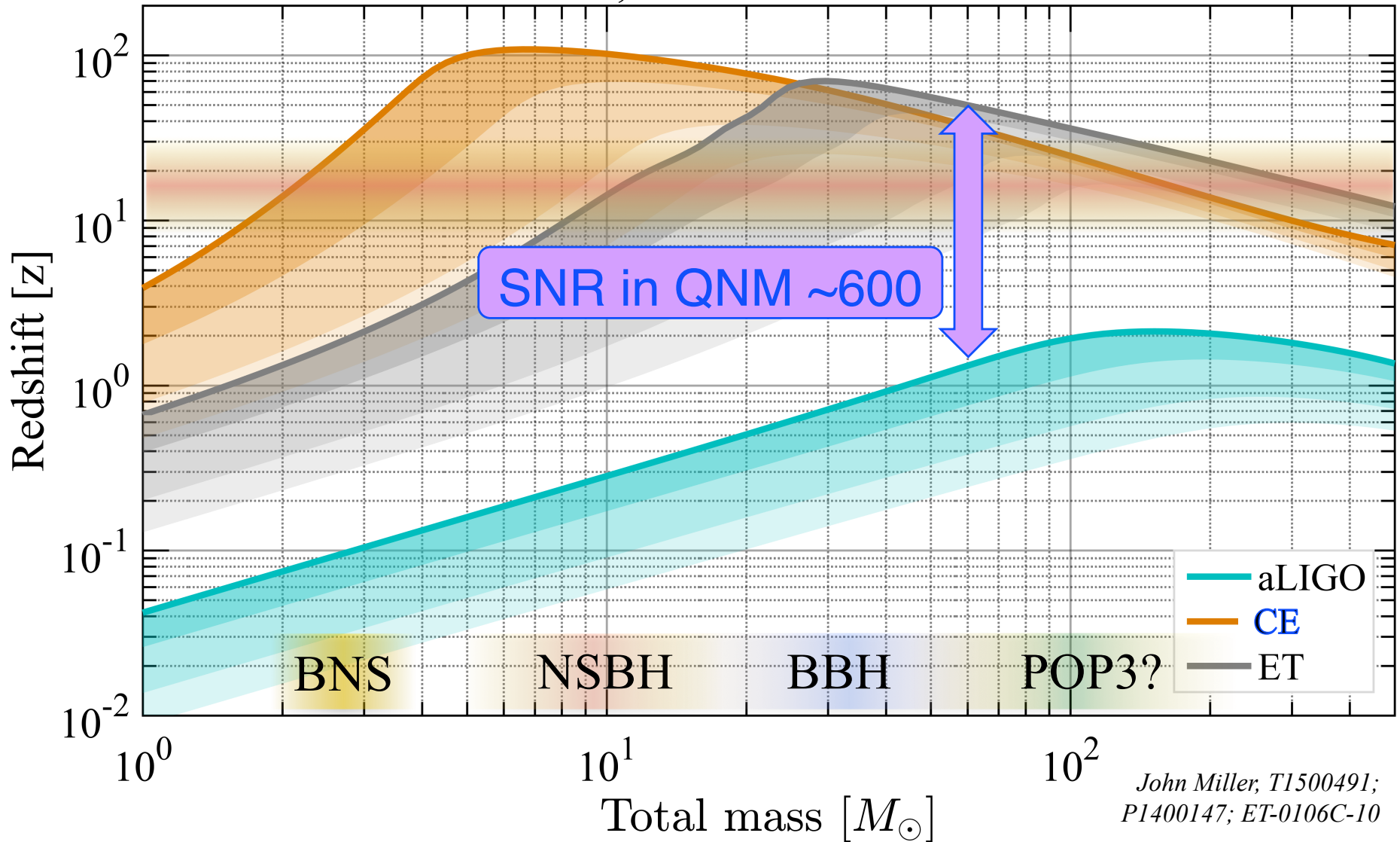

John Miller, T1500491;
P1400147; ET-0106C-10

ZUCKER Sigg et. al



3rd Generation

- When could this new wave of ground instruments come into play?
- Appears 15 years from $t=0$ is a feasible baseline
 - » Initial LIGO: 1989 proposal, and at design sensitivity 2005
 - » Advanced LIGO: 1999 White Paper, GW150914 in 2015
- **Modulo funding, could envision 2030's**
- Should hope – and strive and plan – to have great instruments ready to ‘catch’ the end phase of binaries seen in LISA (ref. Sesana)
- Worldwide community working together on concepts and the best observatory configuration for the science targets
 - » GWIC – the Gravitational Wave International Committee – quite active
- **Crucial for all these endeavors: to expand the scientific community planning on exploiting these instruments far beyond the GR/GW enclave**
 - » Costs are like TMT/GMT/ELT – needs a comparable audience
 - » Events like GW170817 help!

Just the beginning of a new field – new instruments, new discoveries, new synergies

Milliseconds

LIGO/Virgo



**Minutes
to Hours**

LISA

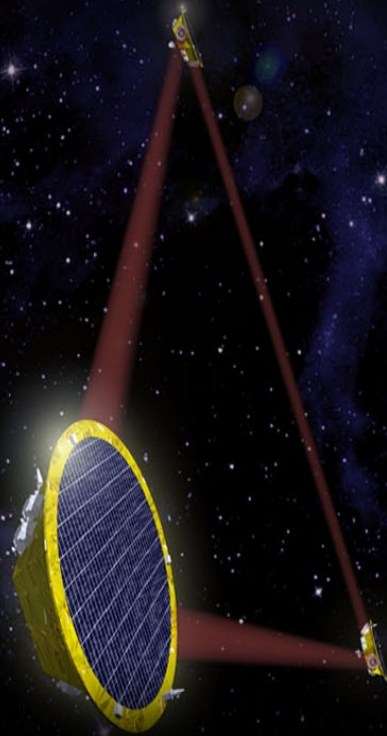

**Years
to Decades**

Pulsar Timing Array



**Billions
of Years**

Cosmology Probes

