

Integrable Bootstrap for Structure Constants in N=4 SYM

Shota Komatsu
(Perimeter Institute)

[B. Basso, P. Vieira, and S.K., arXiv:1505.06745]

[B. Basso, V. Goncalves, P. Vieira and S.K., arXiv:1510.01683]

- We have no satisfactory understanding of AdS/CFT.
- It is important to study in detail how the building blocks of the two theories are related with each other.
- For conformal field theories,
the building blocks \rightarrow 2- and 3-point functions.

$$\langle \mathcal{O}_1 \mathcal{O}_2 \rangle$$

$$\langle \mathcal{O}_1 \mathcal{O}_2 \mathcal{O}_3 \rangle$$

AdS₅/CFT₄ correspondence

N=4 U(N)
SYM in 4d



String Theory on
AdS₅ × S⁵

Goal of this talk:

Non-perturbative framework to compute 3pt-functions
at **finite 't Hooft coupling** in the large N limit.

How?

Map the problem to 2d system and use **Integrability**.

Interesting Observation:

[Eden Heslop Korchemsky Sokatchev]

$$\mathcal{O}_1 : \text{tr}(\tilde{Z}D^2\tilde{Z}) + \dots$$

non-BPS twist 2

$$\mathcal{O}_2 : \text{tr}(Z^3)$$

BPS length 3

$$\mathcal{O}_3 : \text{tr}(\bar{Z}^3)$$

BPS length 3

$$(C_{123})^2 = \frac{1}{6} - 2g^2 + 28g^4 + \dots$$

Interesting Observation:

[Eden Heslop Korchemsky Sokatchev]

$$\mathcal{O}_1 : \text{tr}(\tilde{Z}D^2\tilde{Z}) + \dots$$

non-BPS twist 2

$$\mathcal{O}_2 : \text{tr}(Z^3)$$

BPS length 3

$$\mathcal{O}_3 : \text{tr}(\bar{Z}^3)$$

BPS length 3

$$(C_{123})^2 = \frac{1}{6} - 2g^2 + 28g^4 + \dots$$

$$\mathcal{O}_1 : \text{tr}(\tilde{Z}D^2\tilde{Z}) + \dots$$

non-BPS twist 2

$$\mathcal{O}_2 : \text{tr}(Z^2)$$

BPS length 2

$$\mathcal{O}_3 : \text{tr}(\bar{Z}^2)$$

BPS length 2

$$(C_{123})^2 = \frac{1}{6} - 2g^2 + (28 + 12\zeta(3))g^4 + \dots$$

- Why do they agree up to 1-loop?
- Why do they start to differ at 2-loop?
- How does zeta function come about?

- Why do they agree up to 1-loop?
- Why do they start to differ at 2-loop?
- How does zeta function come about?

Interesting physical mechanism behind!

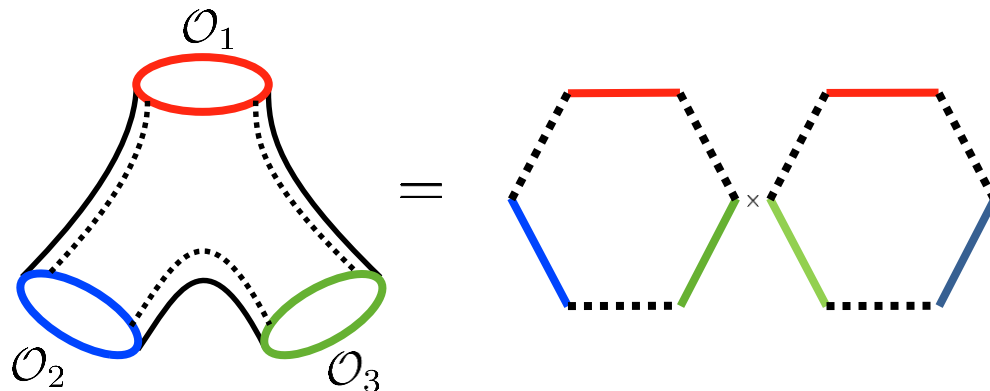

1. Two-point functions
2. Perturbative computation of 3pt functions
3. 3pt from Hexagons (Asymptotic Part)
4. 3pt from Hexagons (“Wrapping” Effects)
5. Outlook

1. Two-point functions

2-point functions

$$\langle \mathcal{O}_i(x_1) \mathcal{O}_j(x_2) \rangle = \frac{\delta_{ij}}{|x_1 - x_2|^{\Delta_i}}$$

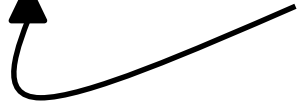
$$\Delta = \Delta_0 + \gamma \quad \text{anomalous dimension}$$

Single trace operators:

$$\mathcal{O}_i = \text{tr} (Z X Z Z D_\mu Z \psi \dots) \quad \text{etc.}$$

$$Z = \phi_1 + i\phi_2, \quad X = \phi_3 + i\phi_4$$

D_μ : covariant derivative

ψ : fermion

Relation to spin chain

[Minahan-Zarembo]

$$\text{tr} (Z X Z Z X \cdots) \longleftrightarrow |\uparrow \downarrow \uparrow\uparrow \downarrow \cdots\rangle$$

$$\text{Diagonalization of } \Gamma_{IJ}^{1\text{-loop}} \longleftrightarrow \text{Diagonalization of } H_{\text{Heisenberg}}$$

$$\gamma_{1\text{-loop}} \longleftrightarrow E_{\text{Heisenberg}}$$

One can efficiently compute the 1-loop anomalous dimension by solving **Bethe equation**.

Bethe equation

General spin-chain state

$$|p_1, p_2, \dots, p_M\rangle =$$

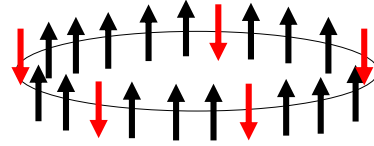

Bethe equation (periodicity condition)

$$e^{ip_j L} \prod_{k \neq j} S_{jk} = 1$$

\iff

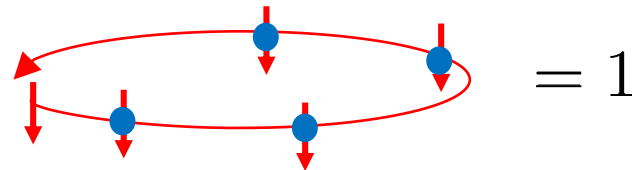

$= 1$

Free propagation

2 to 2 scattering

Energy:

$$\gamma_{1\text{-loop}} = \sum_j E(p_j)$$

Dispersion:

$$E(p) = 2g^2 (\sin p/2)^2 \quad (g^2 = \lambda/4\pi^2)$$

S-matrix:

$$S(p, q) = \frac{\cot p/2 - \cot q/2 + 2i}{\cot p/2 - \cot q/2 - 2i}$$

- One can repeat the same analysis for 2-loop.
- At higher loops, this approach is less effective simply because the computation of the mixing matrix becomes hard.

Use of symmetry [Beisert]

- Consider an infinitely long BPS operator made up of Z's

$$\text{tr} (\cdots ZZZZ \cdots)$$

Use of symmetry [Beisert]

- Consider an infinitely long BPS operator made up of Z's

$$\dots ZZZZ \dots$$

spin-chain vacuum

- Non BPS operators can be constructed by putting **magnons** on top of this vacuum:

$$\dots ZD_{\mu}ZZ \dots$$

Use of symmetry [Beisert]

- Consider an infinitely long BPS operator made up of Z's

$$\dots ZZZZ \dots$$

spin-chain vacuum

- Non BPS operators can be constructed by putting **magnons** on top of this vacuum:

$$\dots Z D_{\mu} Z Z \dots$$

- Symmetry preserved by the “vacuum” is

$$U(1) \times \text{PSU}(2|2)_L \times \text{PSU}(2|2)_R \subset \text{PSU}(2, 2|4)$$

- Magnons belong to the bifundamental irrep of $\text{PSU}(2 | 2)^2$

$$\Psi_{A\dot{A}}$$

$$A = (a|\alpha)$$

$$\dot{A} = (\dot{a}|\dot{\alpha})$$

$$\Psi_{\alpha\dot{\alpha}} = D_{\alpha\dot{\alpha}}$$

$$\Psi_{a\dot{a}} = \Phi_{a\dot{a}}$$

$$\Psi_{a\dot{\alpha}}, \Psi_{\alpha\dot{a}} : \text{fermion}$$

- In addition, the vacuum is invariant under two central charges:

$$C_1 : \dots \Psi \dots \mapsto \dots [Z, \Psi] \dots \quad \leftarrow \{Q, Q\}$$

$$C_2 : \dots \Psi \dots \mapsto \dots [Z^{-1}, \Psi] \dots \quad \leftarrow \{S, S\}$$

* These generators add or subtract one unit of Z. This is the symmetry of the vacuum because the chain is infinite.

- 2 to 2 magnon S-matrix is determined up to a phase by this centrally-extended symmetry.

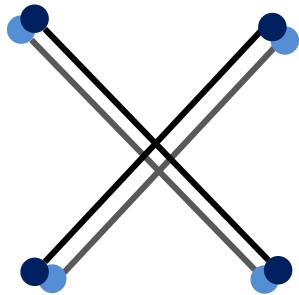

$$\mathcal{S}_{12} = S_{12}^0 \cdot \mathcal{S}_L \times \mathcal{S}_R$$

Phase can be determined by requiring the crossing symmetry of the S-matrix.

- Assuming the factorizability of multi-particle S-matrix, one can write down the finite-coupling version of Bethe eq,

Assumption:

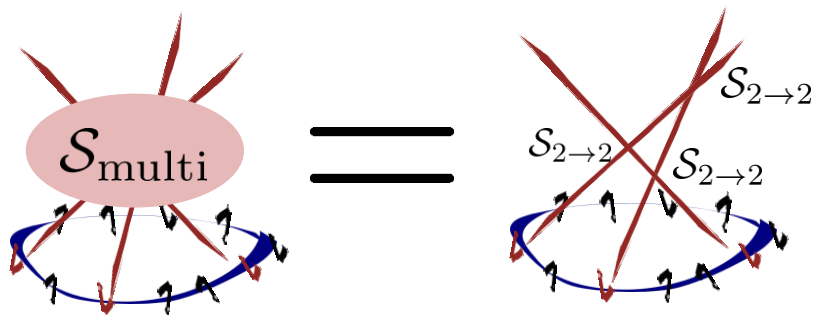

Asymptotic Bethe Ansatz:

$$“e^{ip_j L} \prod_{k \neq j} S_{jk} = 1”$$

Only schematic (actual equations are more complicated)

Energy: $\gamma = \sum_j E(p_j)$

Dispersion: $E(p) = \sqrt{1 + 2g^2(\sin p/2)^2}$

“Rapidity” parametrization:

$$E(p) = \sqrt{1 + 2g^2(\sin p/2)^2}$$



u : living on Riemann surface

$$p(u) = \frac{1}{i} \log \frac{x^+(u)}{x^-(u)}$$

$$E(u) = 1 + 2g \left(\frac{i}{x^+(u)} - \frac{i}{x^-(u)} \right)$$

$$S_{12}^0 = \frac{x_1^+ - x_2^-}{x_1^- - x_2^+} \frac{1 - 1/x_1^- x_2^+}{1 - 1/x_1^+ x_2^-} \frac{1}{\sigma_{12}^2}$$

$$x(u) = \frac{u + \sqrt{u^2 - 4g^2}}{2g}$$

$$x^\pm(u) = x(u \pm i/2)$$

Rapidity torus

$$p(u) = \frac{1}{i} \log \frac{x^+(u)}{x^-(u)}$$

$$E(u) = 1 + 2g \left(\frac{i}{x^+(u)} - \frac{i}{x^-(u)} \right)$$

$$x(u) = \frac{u + \sqrt{u^2 - 4g^2}}{2g}$$

u

$-2g + i/2$ — — — — — $2g + i/2$
cut for x^-

$-2g - i/2$ — — — — — $2g - i/2$
cut for x^+

Finite size correction

[Ambjorn, Janik, Kristjansen]

- For a finite-size operator, there are corrections coming from virtual particles going around the chain and scattering physical particles.

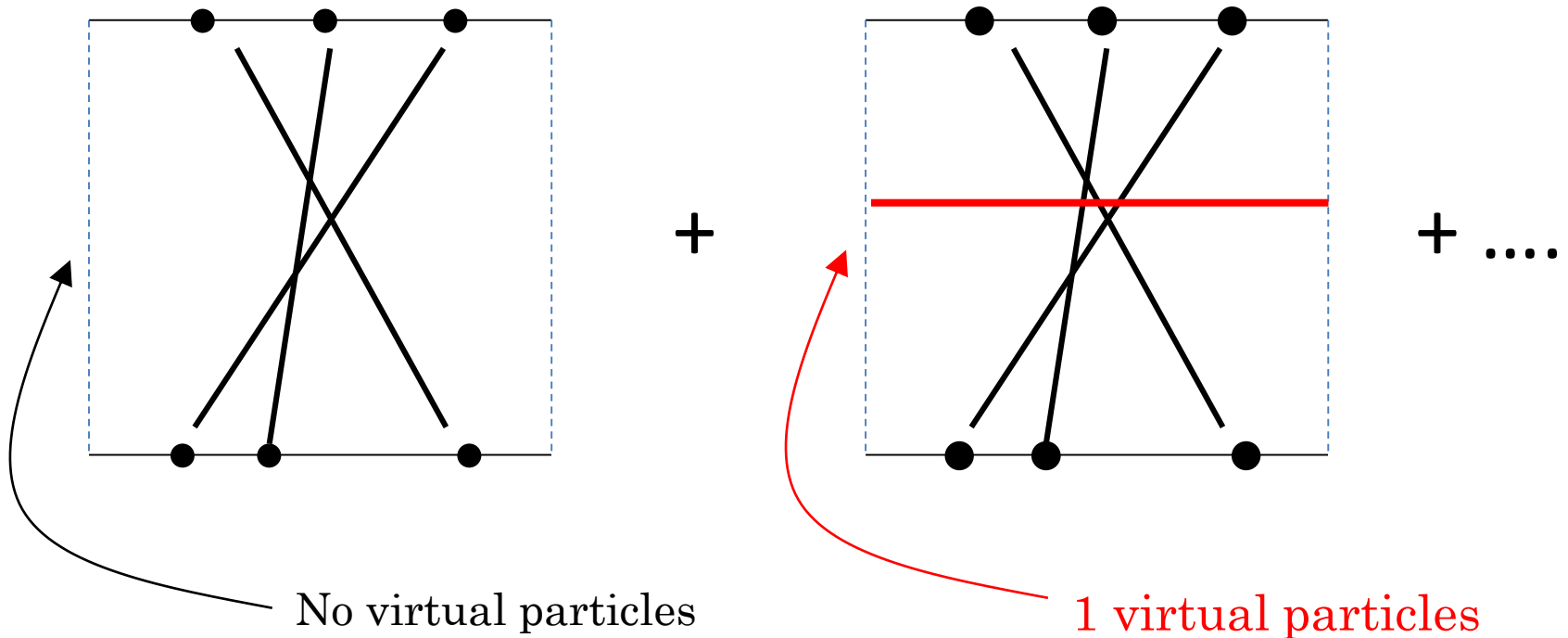

No virtual particles

1 virtual particles

$$e^{-LE_{\text{virtual}}} \sim O(g^{2L})$$

Virtual particle from “mirror transformation”

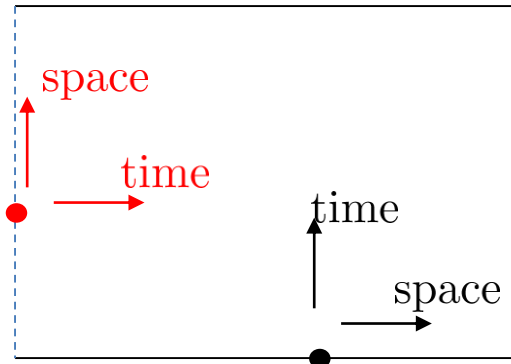

$$E^2 = 1 + 4g^2(\sin p/2)^2$$

$$\mapsto p_{\text{mirror}}^2 = -1 + 4g^2(\sinh E_{\text{mirror}}/2)^2$$

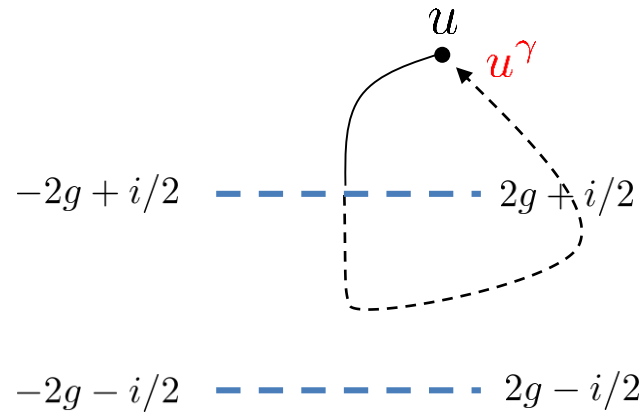

$$E \rightarrow ip_{\text{mirror}}$$

$$p \rightarrow iE_{\text{mirror}}$$

Mirror dispersion is obtained by the analytic continuation
in the u -space

Virtual particle from “mirror transformation”

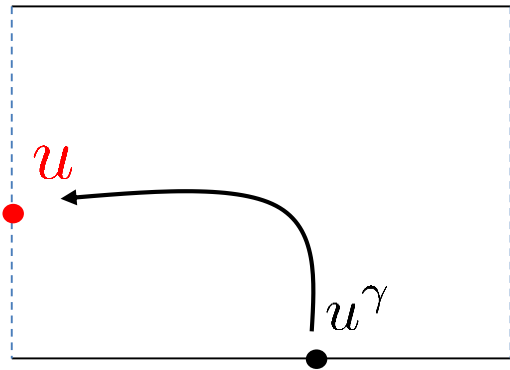

$$E^2 = 1 + 4g^2 (\sin p/2)^2$$

$$\mapsto p_{\text{mirror}}^2 = -1 + 4g^2 (\sinh E_{\text{mirror}}/2)^2$$

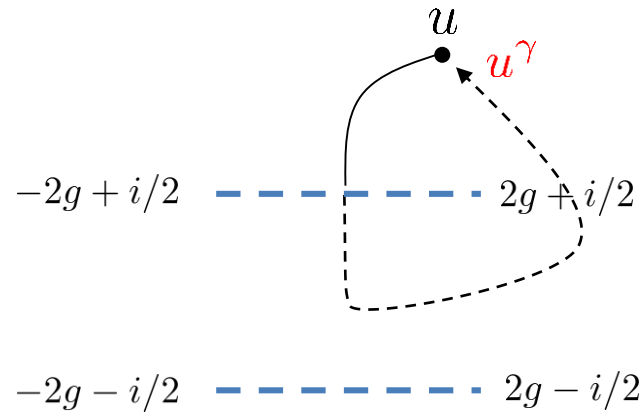

$$E \rightarrow ip_{\text{mirror}}$$

$$p \rightarrow iE_{\text{mirror}}$$

Mirror dispersion is obtained by the analytic continuation
in the u -space

Lessons from 2pt functions

- First study infinitely long operators.
- Make use of (centrally extended) symmetry.
- Finite size corrections from virtual particles.
- One can move a particle from one edge to the other by the “mirror transformation”.

2. Perturbative computation of 3pt functions

3-point functions

$$\langle \mathcal{O}_i(x_1) \mathcal{O}_j(x_2) \mathcal{O}_k(x_3) \rangle = \frac{C_{ijk}}{|x_1 - x_2|^{\Delta_i + \Delta_j - \Delta_k} |x_2 - x_3|^{\Delta_j + \Delta_k - \Delta_i} |x_3 - x_1|^{\Delta_k + \Delta_i - \Delta_j}}$$

Perturbative computation

Tree-level:

[Okuyama-Tseng] [Roiban-Volovich][Alday-David-Narain-Gava]

[Escobedo-Gromov-Sever-Vieira] [Foda] [Kazama-Nishimura-S.K.]

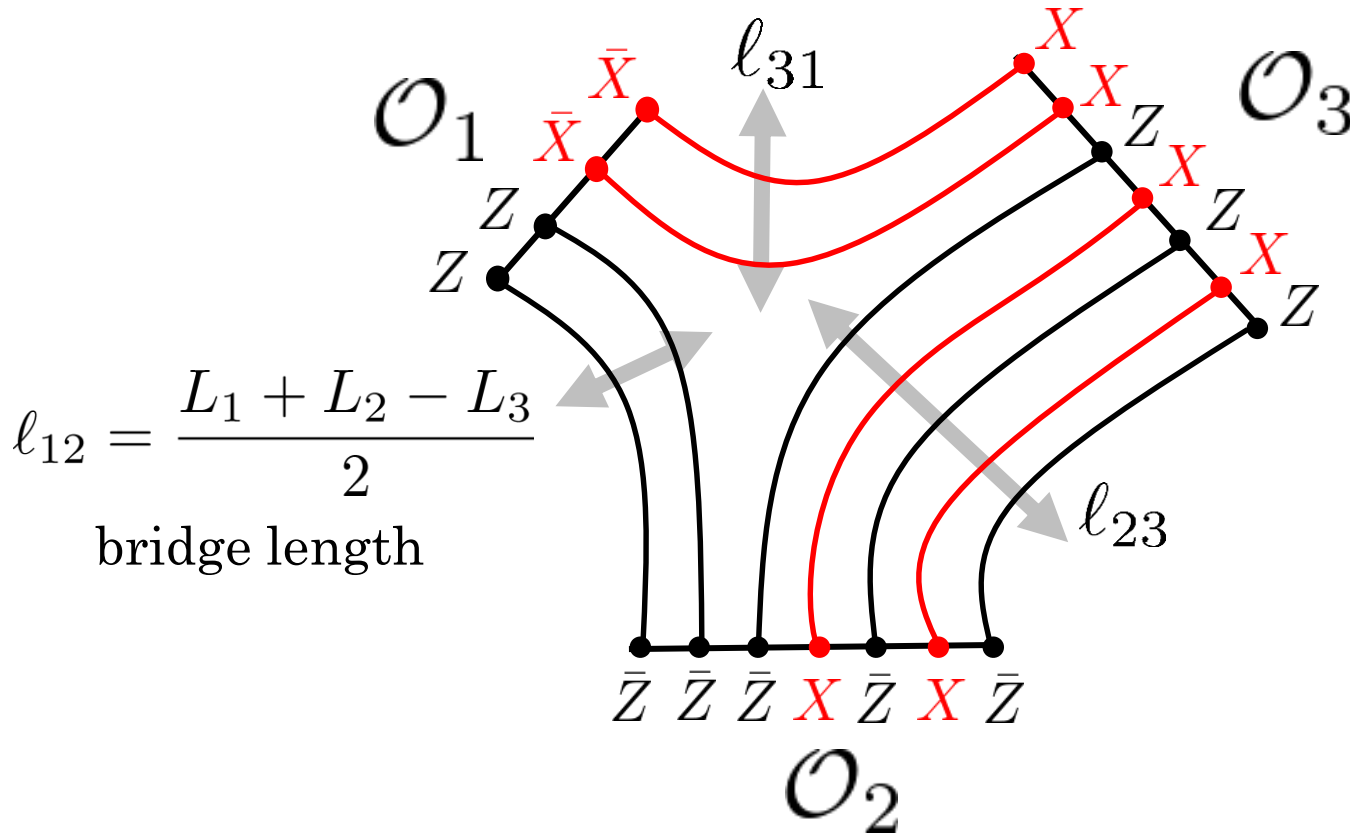

$$\mathcal{O}_1 : \text{tr} (ZZ\bar{X}\bar{X}) + \dots$$

Perturbative computation

Result (tree-level SL(2) sector):

$$\mathcal{O}_1 : \{u\}, \quad \mathcal{O}_2 : \{ \}, \quad \mathcal{O}_3 : \{ \}$$

$$C_{123} = \sum_{\alpha \cup \bar{\alpha} = \{u\}} (-1)^{\bar{\alpha}} e^{ip_{\bar{\alpha}} \ell_{12}} \prod_{s \in \alpha, t \in \bar{\alpha}} f(s, t)$$

$$f(s, t) = \frac{u - v - i}{u - v}$$

$$\frac{f(v, u)}{f(u, v)} = S^{1-\text{loop}}(u, v)$$

square-root of S-matrix

Perturbative computation

1-loop:

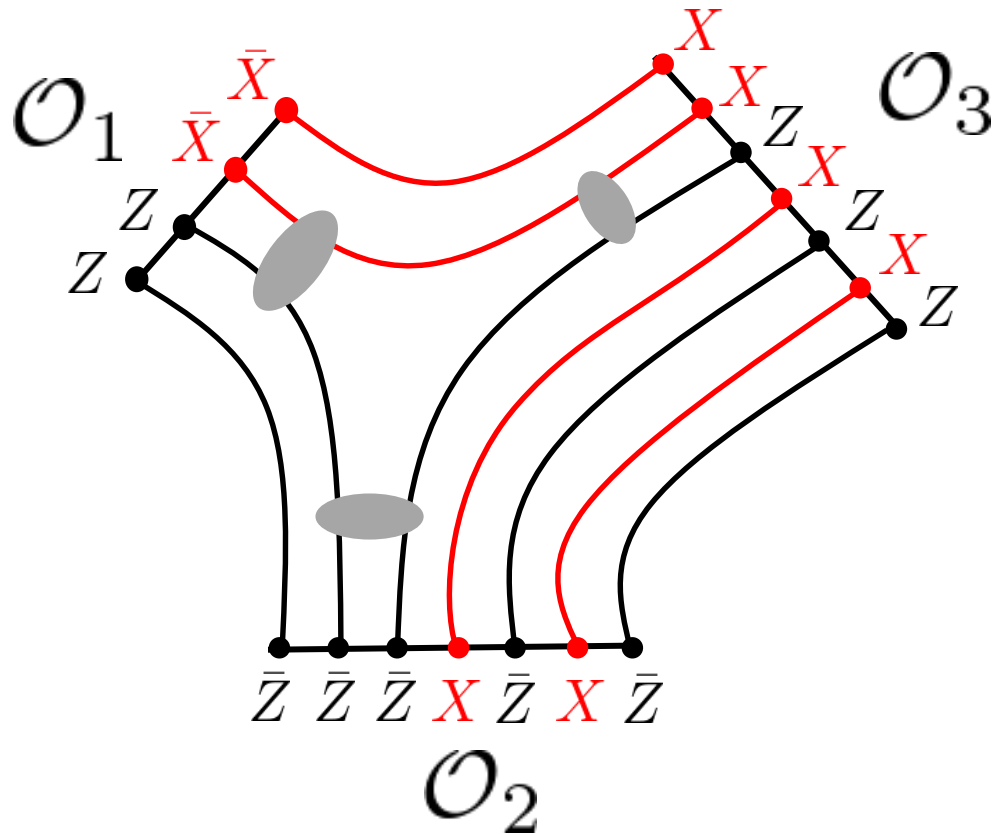

The actual computation is much more complicated.

Perturbative computation

Result (one-loop SL(2) sector):

[Vieira-Wang]

$$\mathcal{O}_1 : \{u\}, \quad \mathcal{O}_2 : \{ \}, \quad \mathcal{O}_3 : \{ \}$$

$$C_{123} = \sum_{\alpha \cup \bar{\alpha} = \{u\}} (-1)^{\bar{\alpha}} e^{ip_{\bar{\alpha}} \ell_{12}} \prod_{s \in \alpha, t \in \bar{\alpha}} f(s, t)$$

$$f(s, t) = \frac{u - v - i}{u - v} \left(1 - \frac{g^2(u - v - i)}{(u^2 + 1/4)(v^2 + 1/4)} \right)$$

$$\frac{f(v, u)}{f(u, v)} = S^{2\text{-loop}}(u, v)$$

Lessons from perturbative 3pt

- 3pt = sum over partition of magnons
- Building block = “square-root” of the S-matrix.

3. 3pt from Hexagons

3pt

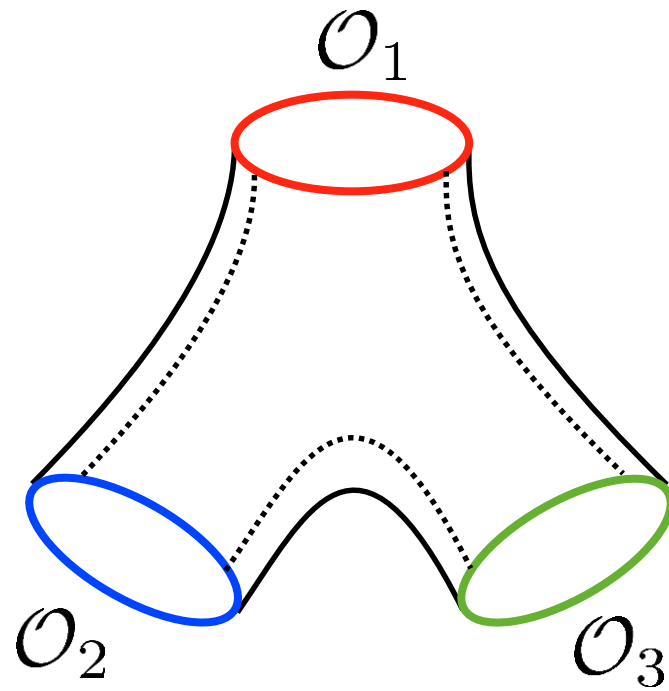

$$3\text{pt} = \text{Hexagon}^2$$

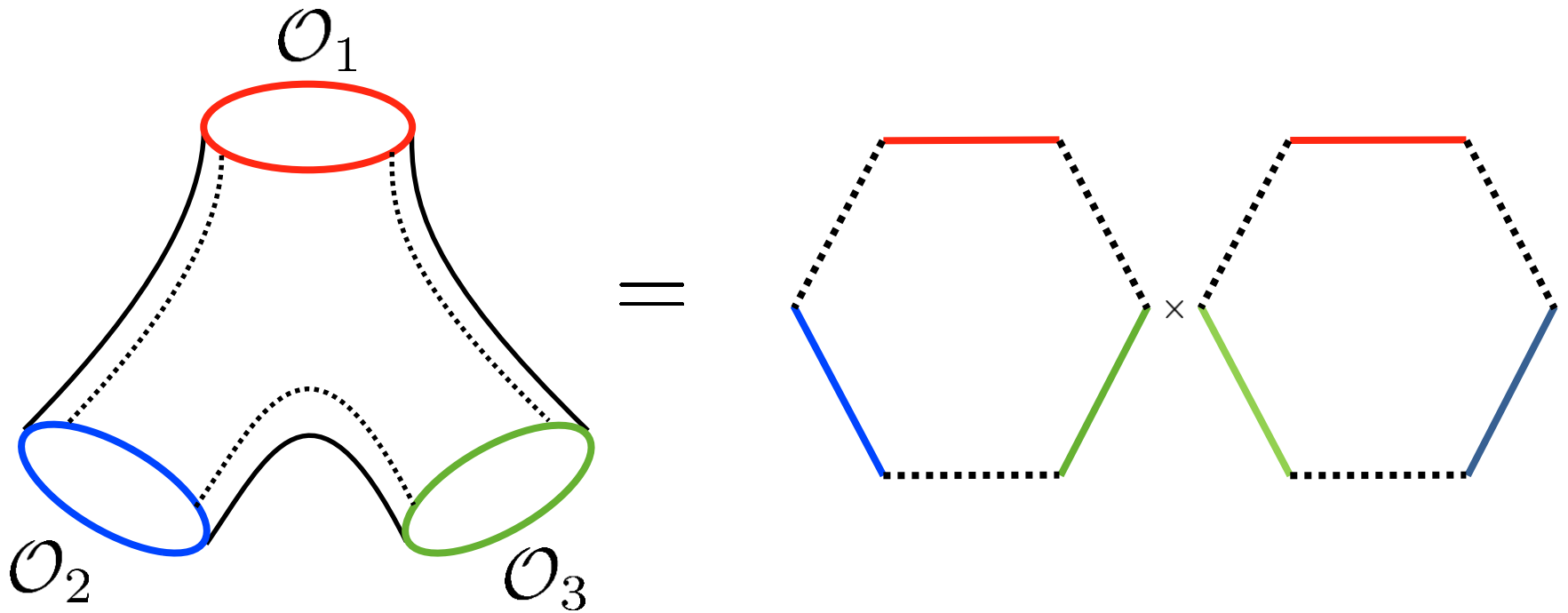

More precisely...

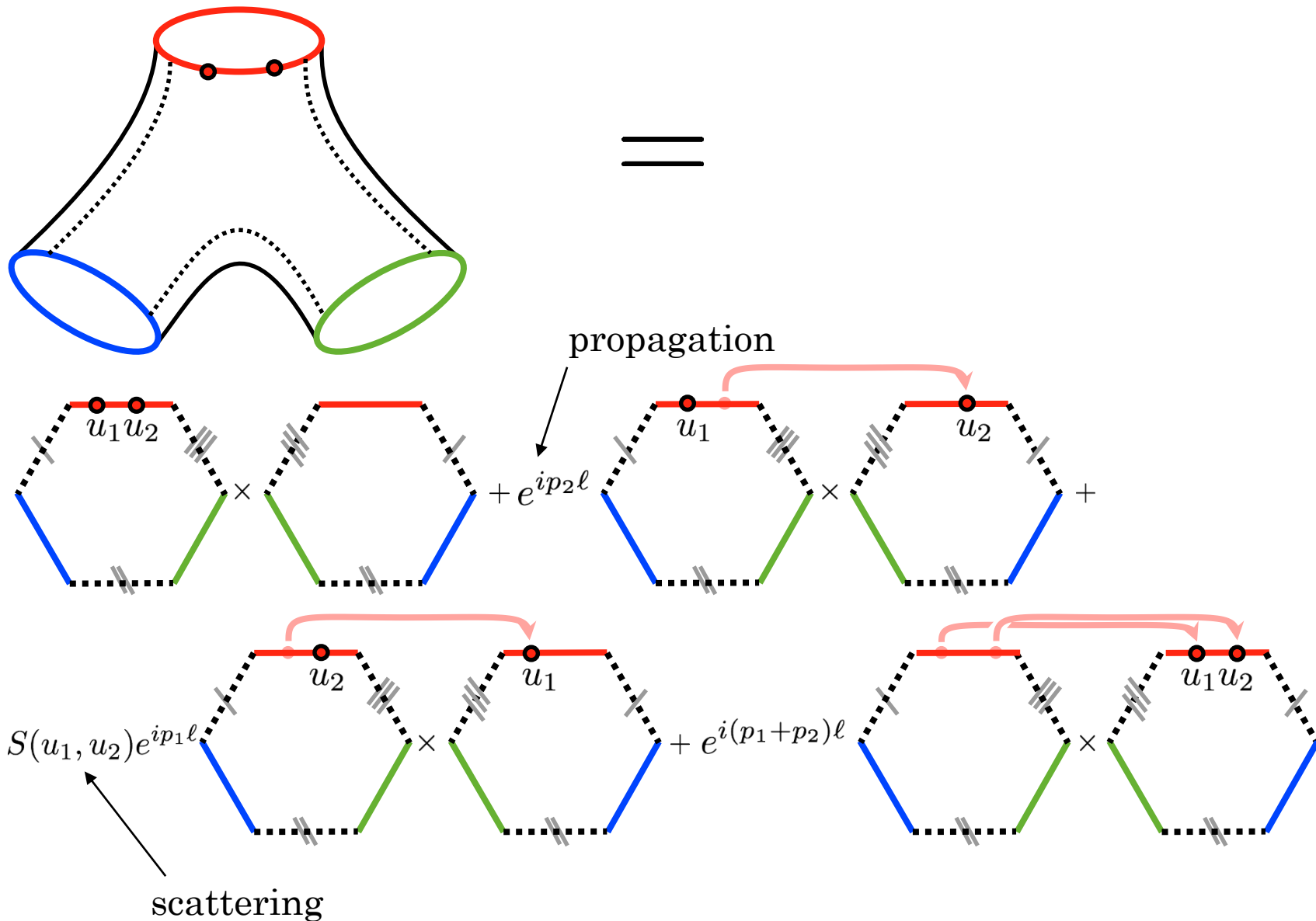

More precisely...

Sum over partitions!

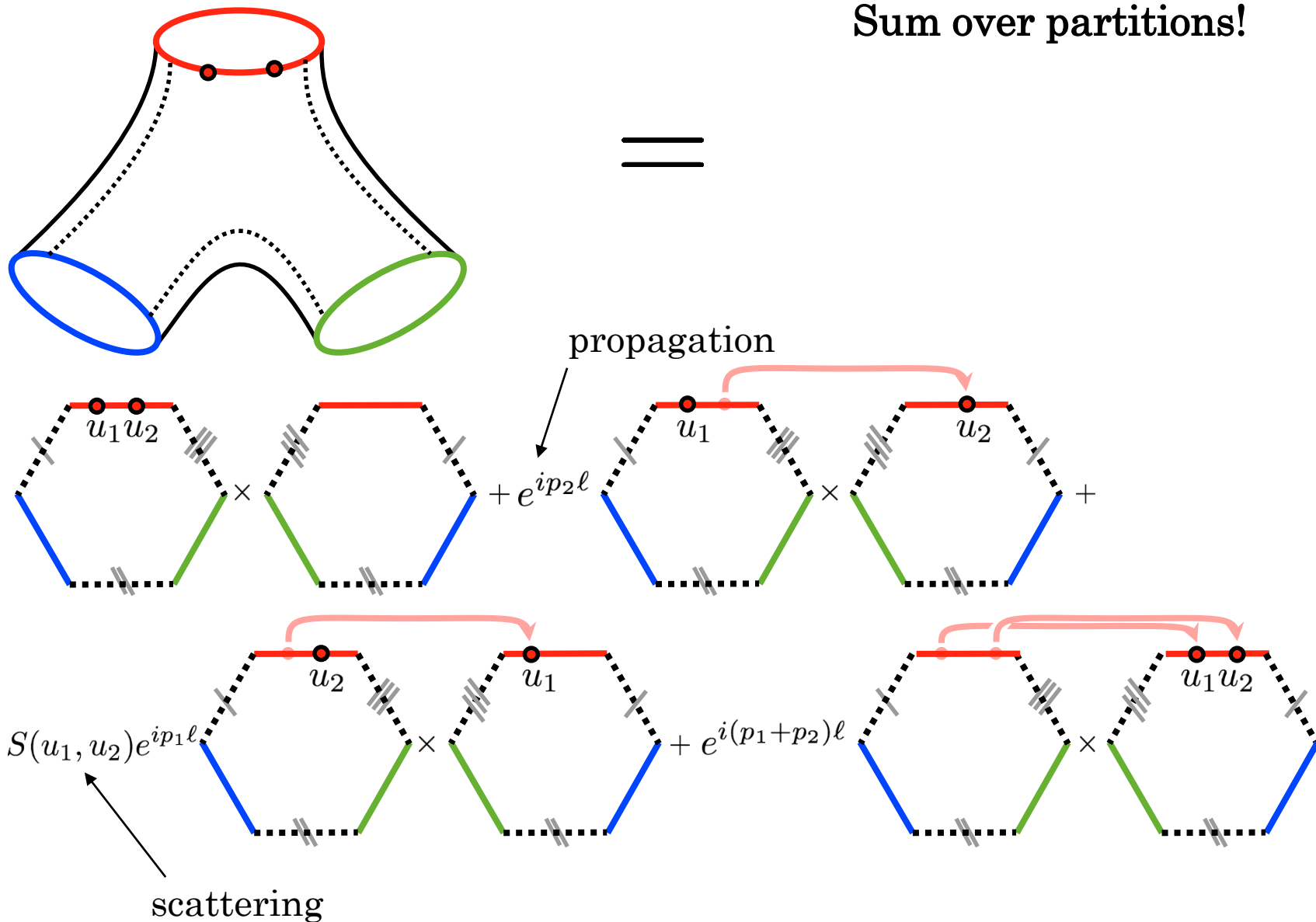

Building block = Hexagon form factor

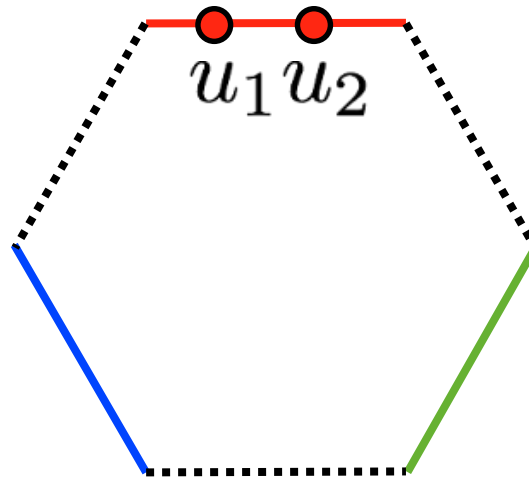

Severely constrained by the symmetry
(+ Integrable bootstrap equations)

Use of symmetry

$$\text{BPS 3pt} = \langle \text{tr} \tilde{Z}^{L_1}(x_1) \text{tr} \tilde{Z}^{L_2}(x_2) \text{tr} \tilde{Z}^{L_3}(x_3) \rangle$$

$$\begin{aligned} \tilde{Z}(x) &\equiv e^{\mathcal{T}a} \cdot Z(0) \\ &= ((1 + a^2)\phi_1 + i(1 - a^2)\phi_2 + ia\phi_3) (0, a, 0, 0) \end{aligned}$$

$$\mathcal{T} = -i\epsilon_{\alpha\dot{\alpha}} P^{\alpha\dot{\alpha}} + \epsilon_{a\dot{a}} R^{a\dot{a}}$$

Twisted translation

Residual symmetry =

$$\text{PSU}(2|2) \times \text{PSU}(2|2) \rightarrow \text{PSU}(2|2)_D$$

$$\begin{aligned} &\cup \\ &O(3) \times O(3) + 8(Q + S) \end{aligned}$$

Use of symmetry

One magnon form factor

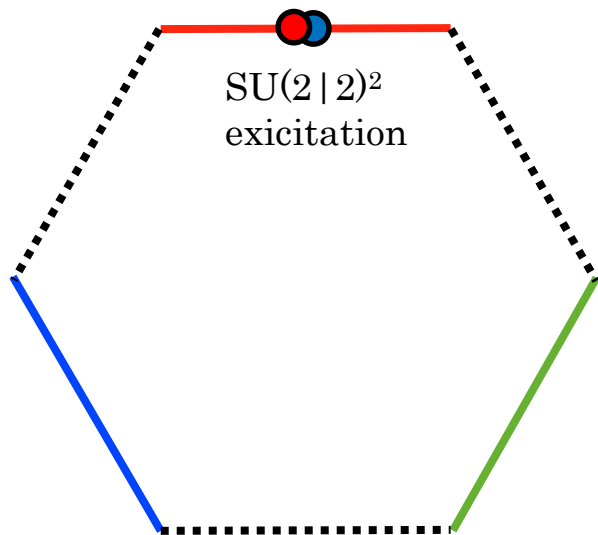

=

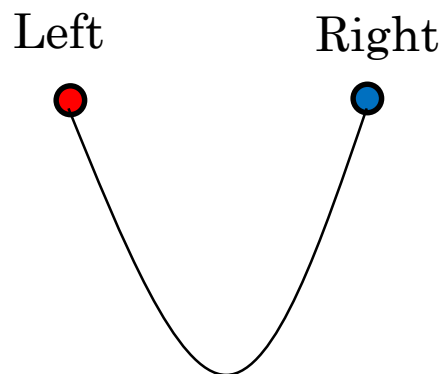

$\mathfrak{h}_{AA'}$

\propto

$\epsilon_{AA'}$

$$\begin{pmatrix} \epsilon_{a\dot{a}} & 0 \\ 0 & \epsilon_{\alpha\dot{\alpha}} \end{pmatrix}$$

Use of symmetry

Two magnon form factor

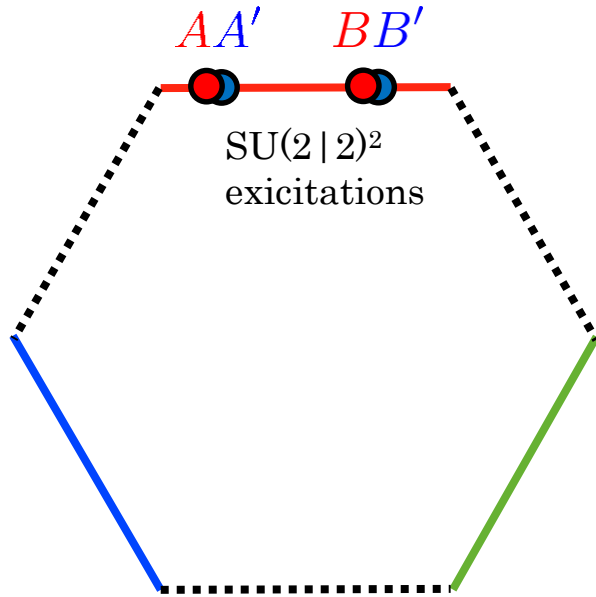

=

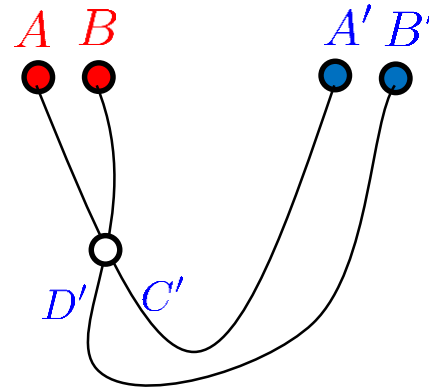

SU(2|2) S-matrix

$$\mathfrak{h}_{AA'|BB'} = h_{12} \times \epsilon_{A'C'} \epsilon_{B'D'} \mathcal{S}_{AB}^{C'D'}$$

“square-root” of S-matrix

$$(\mathcal{S}_{12} = \mathcal{S}_{12}^0 \cdot \mathcal{S}_L \times \mathcal{S}_R)$$

Use of symmetry

Multi-magnon form factor

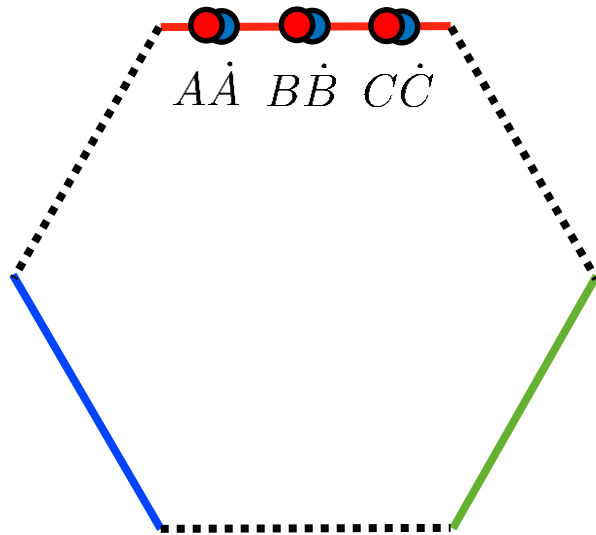

$=$

$$\prod_{i < j} h_{ij}$$

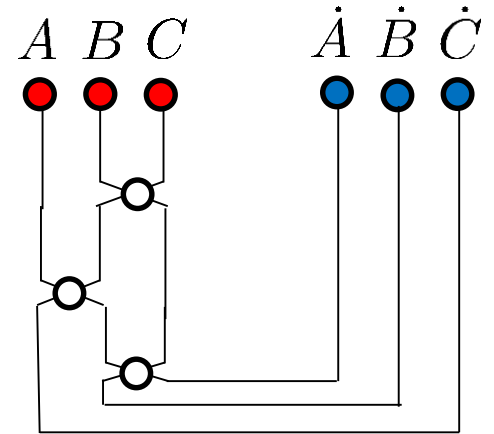

SU(2|2) S-matrices

Bootstrap eq. for h_{12}

Watson eq. :

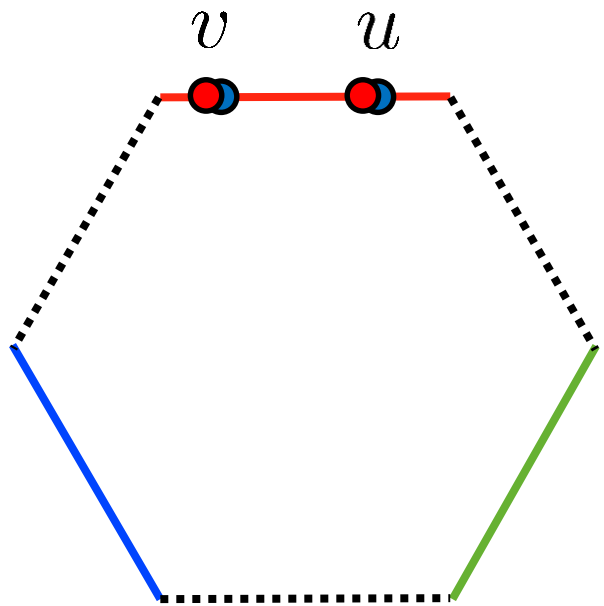

=

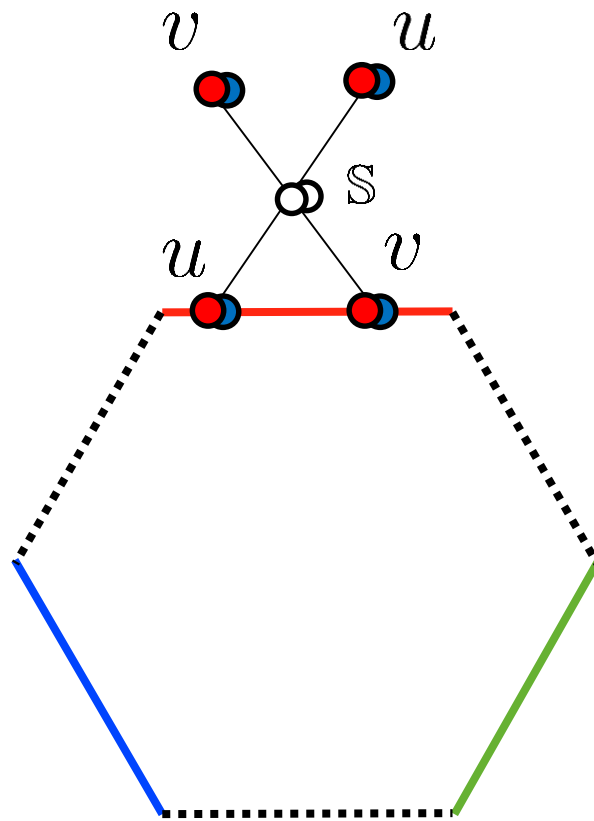

$$h_{12} = S_{12}^0 h_{21}$$

Bootstrap eq. for h_{12}

Crossing eq. :

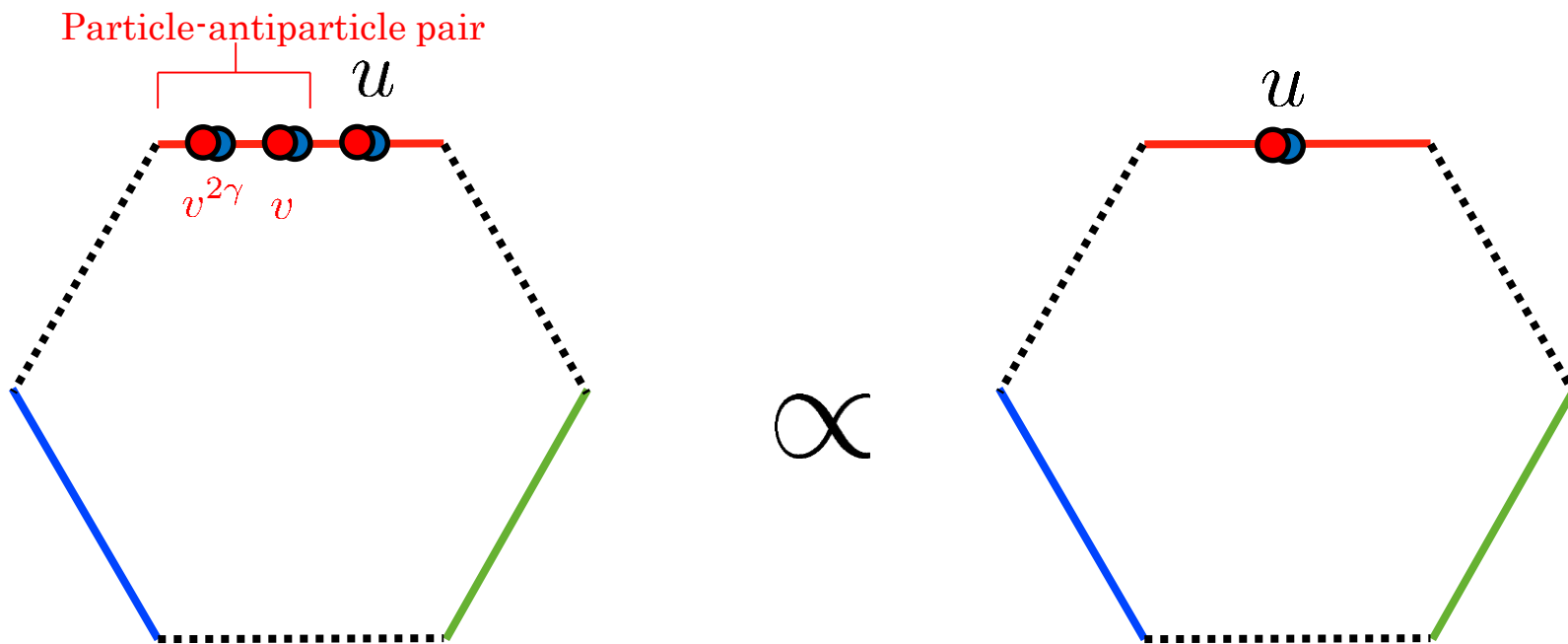

$$h(v^{2\gamma}, u)h(v, u) = \frac{x^-(v) - x^-(u)}{x^-(v) - x^+(u)} \frac{1 - 1/x^+(v)x^-(u)}{1 - 1/x^+(v)x^+(u)}$$

Solution:

$$h_{12} = \frac{x_1^- - x_2^-}{x_1^- - x_2^+} \frac{1 - 1/x_1^- x_2^+}{1 - 1/x_1^+ x_2^+} \frac{1}{\sigma_{12}}$$

(Not unique but this choice is the simplest and correctly reproduces the weak-coupling result.)

All-loop prediction

$$\mathcal{O}_1 : \{u\}, \quad \mathcal{O}_2 : \{ \}, \quad \mathcal{O}_3 : \{ \}$$

$$C_{123} \propto \sum_{\alpha \cup \bar{\alpha} = \{u\}} (-1)^{\bar{\alpha}} e^{ip_{\bar{\alpha}} \ell_{12}} \prod_{s \in \alpha, t \in \bar{\alpha}} \frac{1}{h(s, t)}$$

$$\frac{h(u, v)}{h(v, u)} = S_{12}^0(u, v)$$

Bridge-length 2

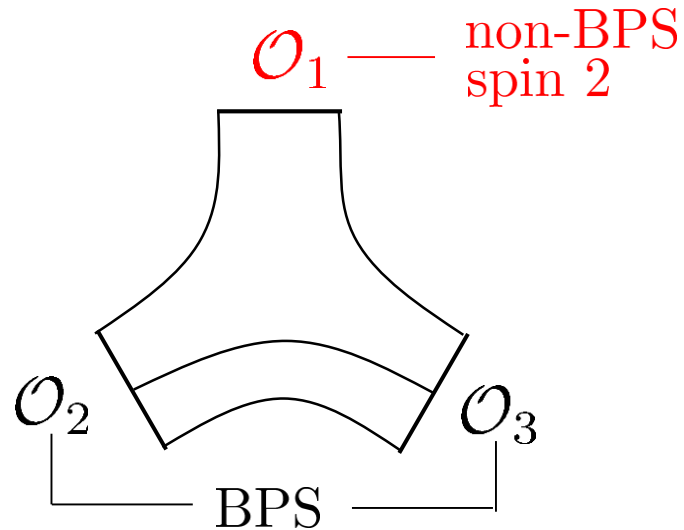

$$(C_{123})^2 = \frac{1}{6} - 2g^2 + 28g^4 + \dots$$

Matches with the OPE decomposition of 4pt functions of BPS ops.

[Sokatchev et al.]

Bridge-length 1

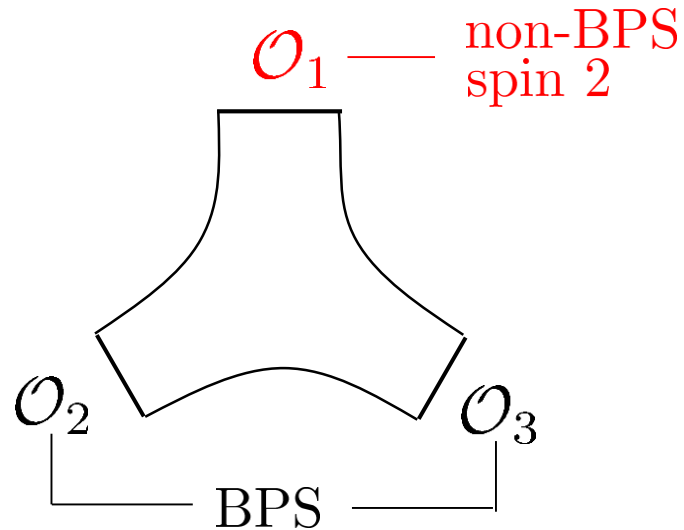

$$(C_{123})^2 = \frac{1}{6} - 2g^2 + (28 + 12\zeta(3))g^4 + \dots$$

Perturbation result contains a zeta-function part, which cannot be reproduced by the sum over partitions.

4. Finite size correction to Hexagons

Finite size correction

In addition to sum over partitions, we should include the virtual-particle corrections

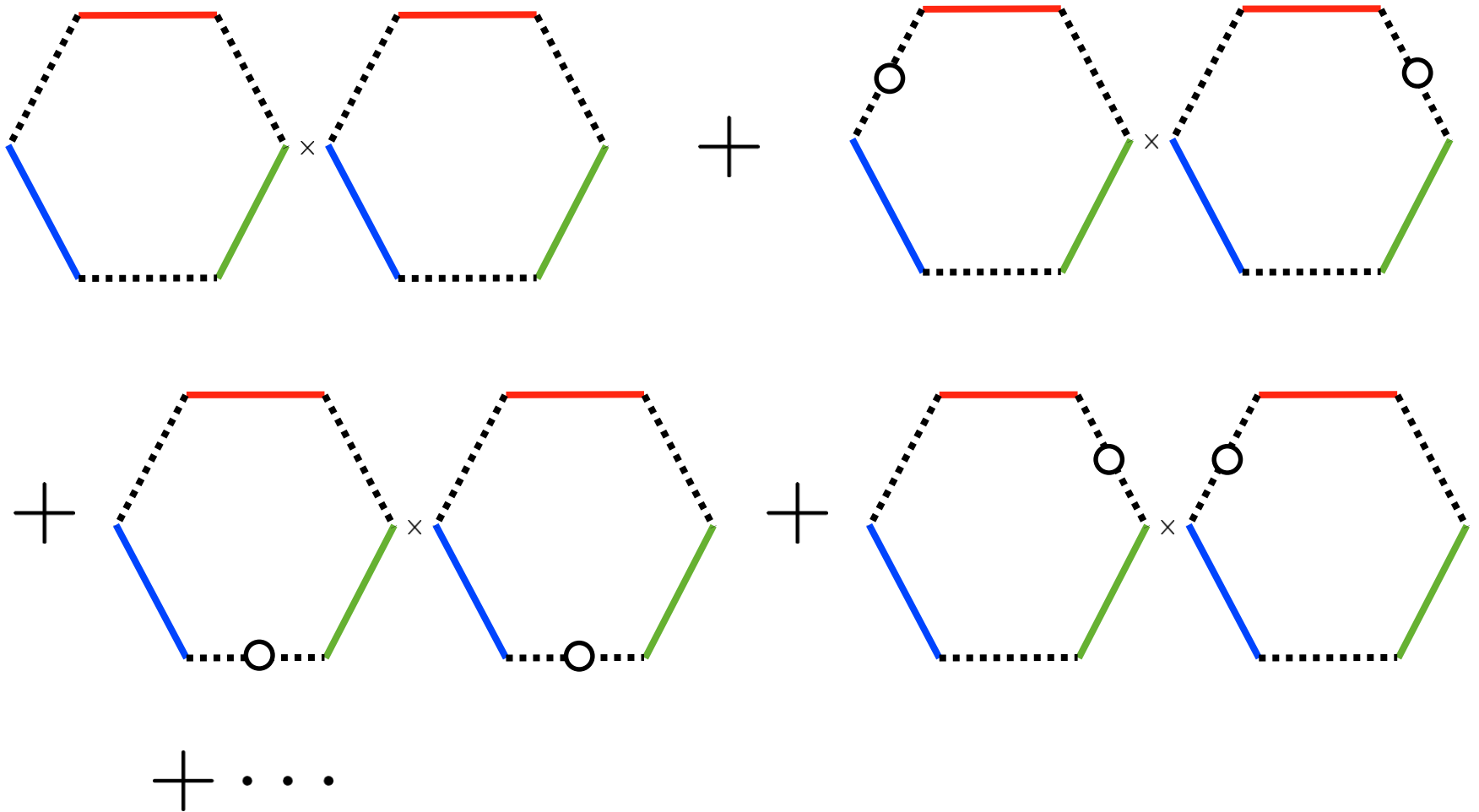

Virtual particle corrections

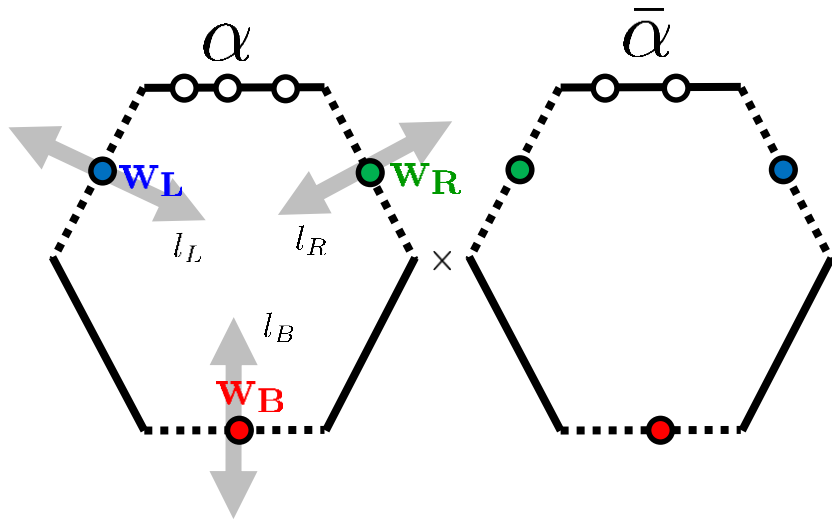

$$= \int d\mathbf{w}_B \int d\mathbf{w}_L \int d\mathbf{w}_R \text{Integrand}$$

$$\text{Integrand} = \underline{e^{-E(\mathbf{w}_B)l_L} e^{-E(\mathbf{w}_L)l_L} e^{-E(\mathbf{w}_R)l_L} \times \dots}$$

Suppression coming from the propagation of the virtual particles

$$\mathcal{O} \left(g^{2(n_B l_B + n_L l_L + n_R l_R)} \right)$$

Virtual particle corrections from mirror transformation

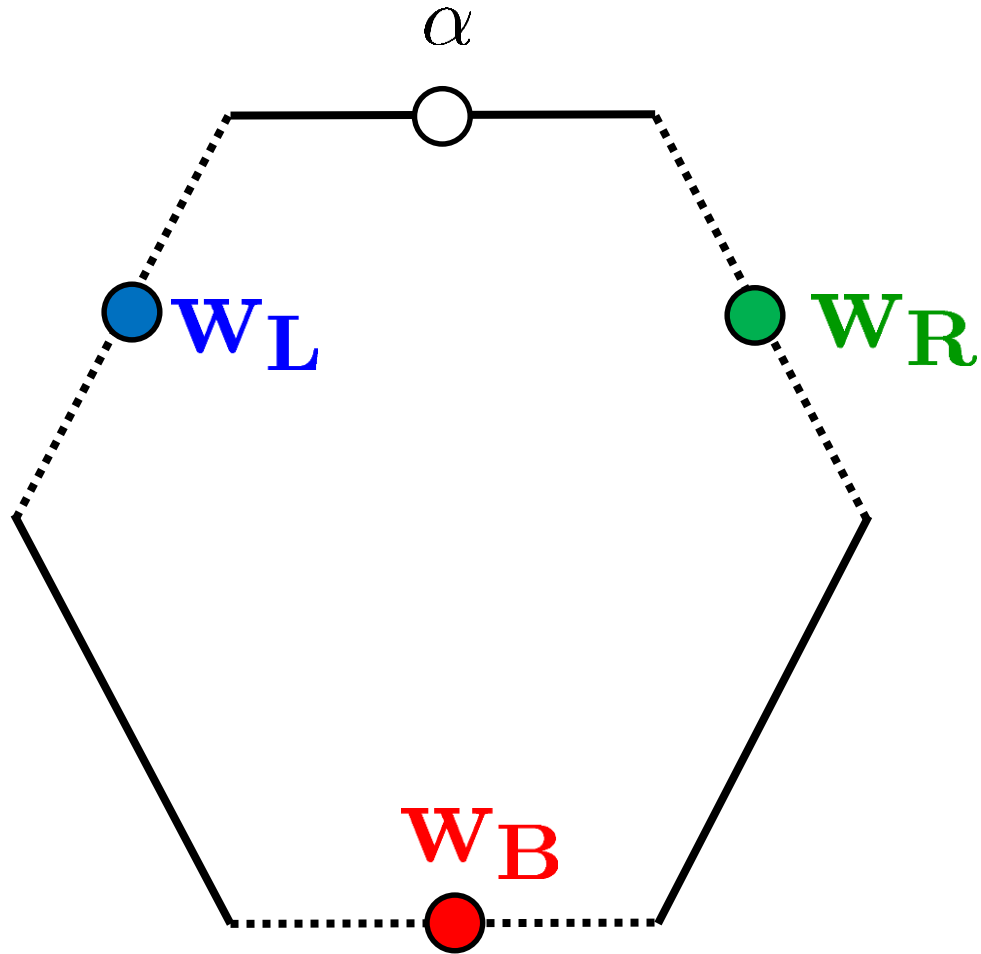

Virtual particle corrections from mirror transformation

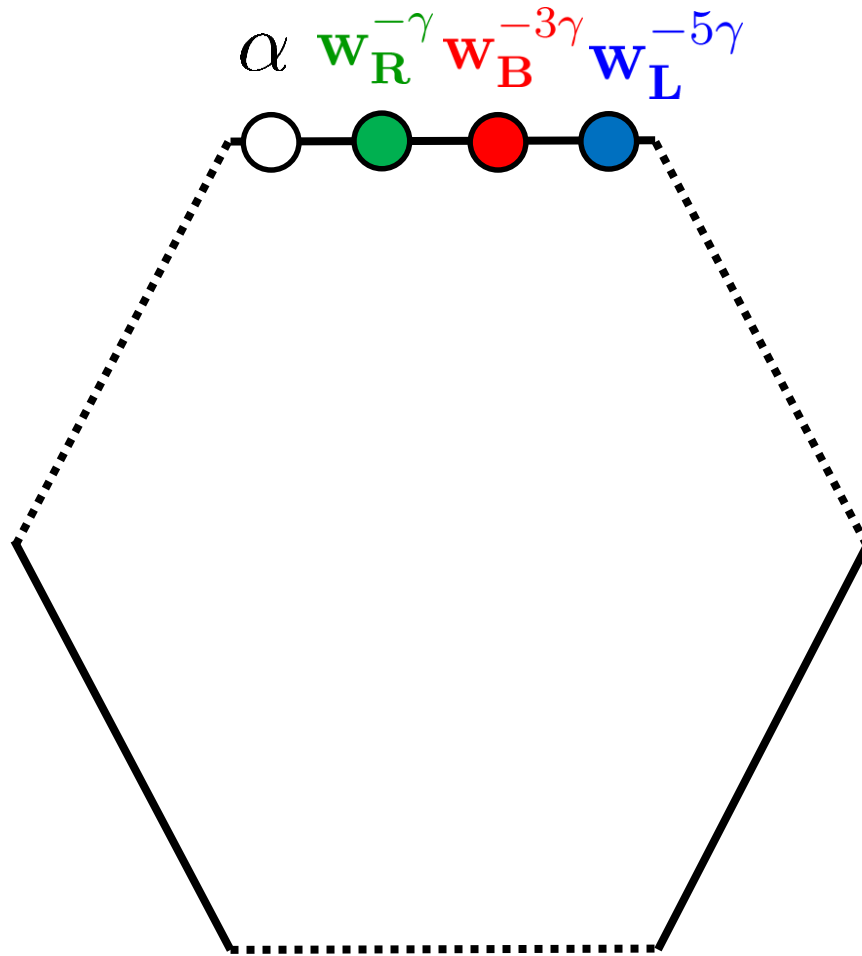

Virtual particle corrections from mirror transformation

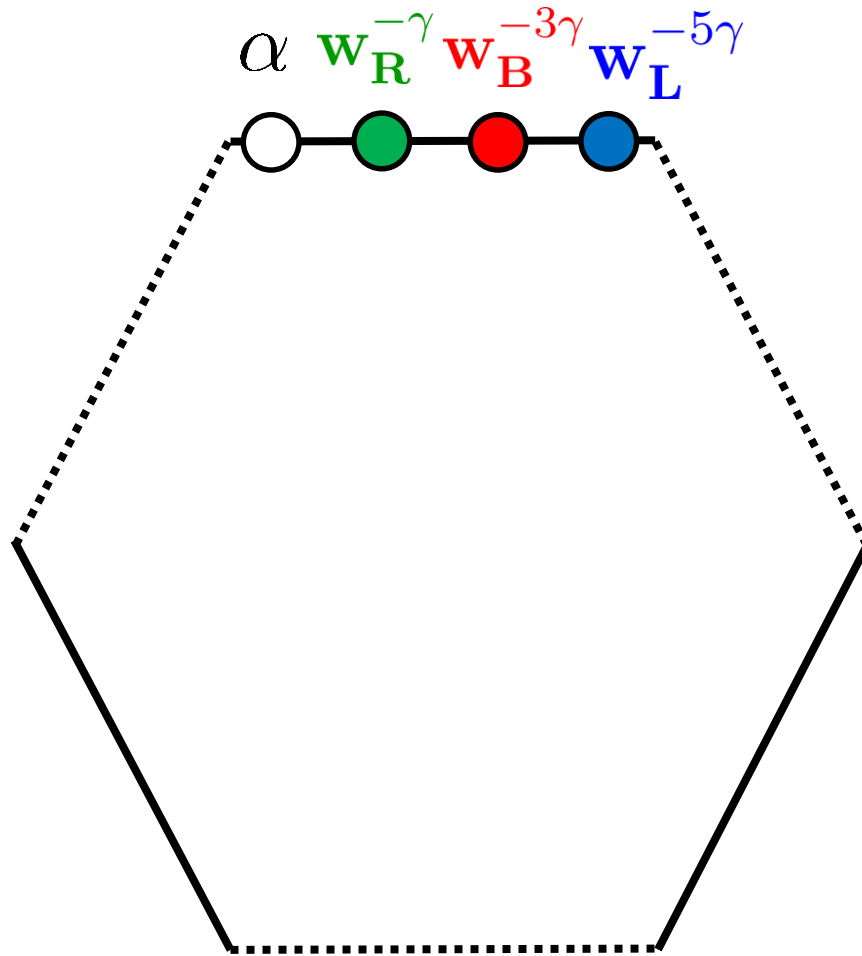

$$h(\alpha, w_R^{-\gamma})h(\alpha, w_B^{-3\gamma})h(\alpha, w_L^{-5\gamma})$$

Full expression for the integrand

$$\begin{aligned}
 \text{Integrand} &= \mu(\mathbf{w}_B^\gamma) \mu(\mathbf{w}_L^\gamma) \mu(\mathbf{w}_R^\gamma) e^{-E(\mathbf{w}_B)l_B} e^{-E(\mathbf{w}_L)l_L} e^{-E(\mathbf{w}_R)l_R} T(\mathbf{w}_B^\gamma) T(\mathbf{w}_L^{-\gamma}) T(\mathbf{w}_R^{-\gamma}) \\
 &\times h^\neq(\mathbf{w}_B^\gamma, \mathbf{w}_B^\gamma) h^\neq(\mathbf{w}_L^\gamma, \mathbf{w}_L^\gamma) h^\neq(\mathbf{w}_R^\gamma, \mathbf{w}_R^\gamma) h(\mathbf{w}_L^{-\gamma}, \mathbf{w}_R^{-5\gamma}) h(\mathbf{w}_R^{-\gamma}, \mathbf{w}_L^{-5\gamma}) \\
 &\times h(\mathbf{u}, \mathbf{w}_B^{-3\gamma}) \sum_{\alpha \cup \bar{\alpha} = \mathbf{u}} (-1)^{|\bar{\alpha}|} e^{ip_{\bar{\alpha}}l_R} \frac{h(\alpha, \mathbf{w}_L^{-5\gamma}) h(\alpha, \mathbf{w}_R^{-\gamma}) h(\bar{\alpha}, \mathbf{w}_L^{-\gamma}) h(\bar{\alpha}, \mathbf{w}_R^{-5\gamma})}{h(\alpha, \bar{\alpha})}
 \end{aligned}$$

$$\text{Measure: } \mu(u) = \text{Res}_{u=v} \frac{1}{h(u, v)}$$

Transfer matrix: $T(u)$
 (comes from
 matrix structure)

Virtual particle corrections

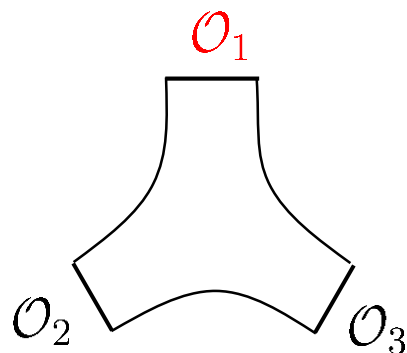

Tree-level and 1-loop:

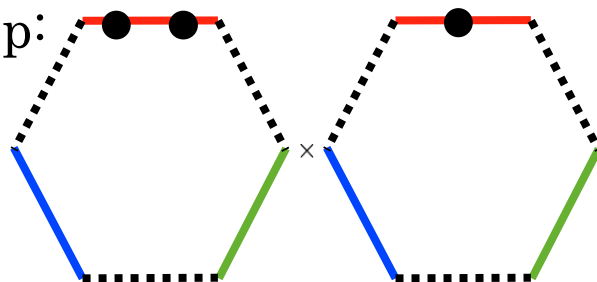

2-loop:

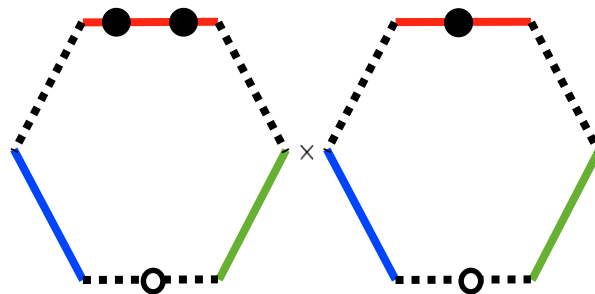

$$(C_{123})^2 = \frac{1}{6} - 2g^2 + (28 + 12\zeta(3))g^4 + \dots$$

Zeta function indeed comes from the mirror particle.

Virtual particle corrections

Tree-level and 1-loop:

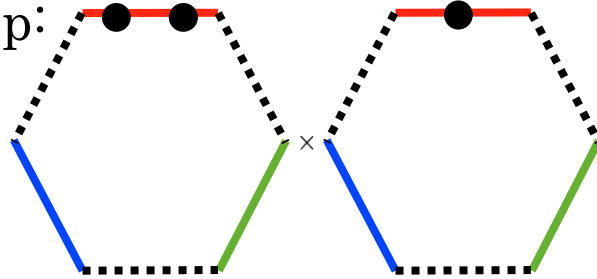

2-loop:

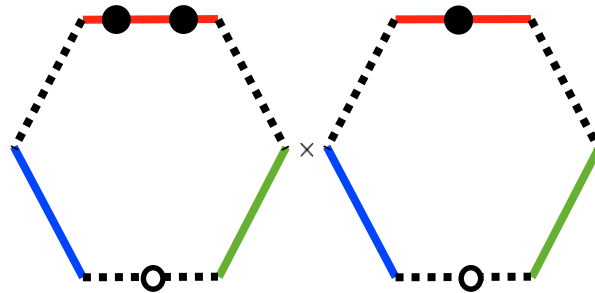

3-loop:

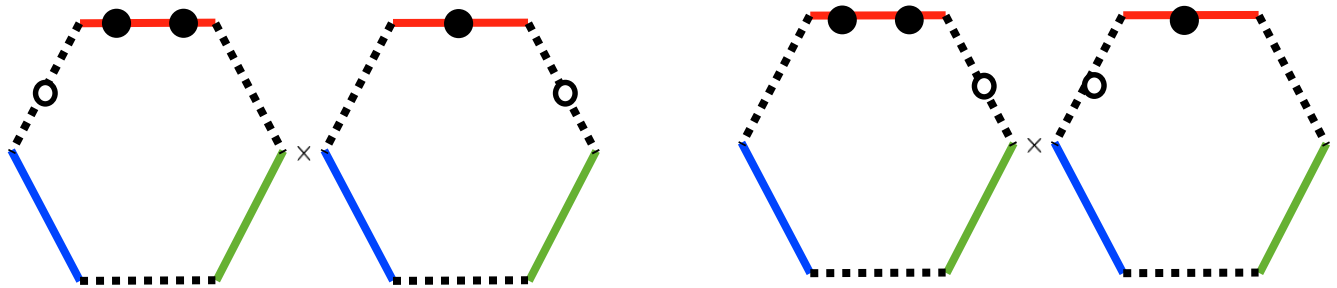

Virtual particle corrections

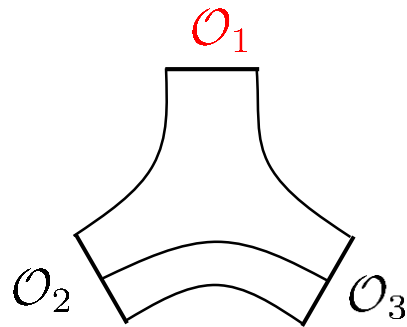

Tree-level and 1-loop:

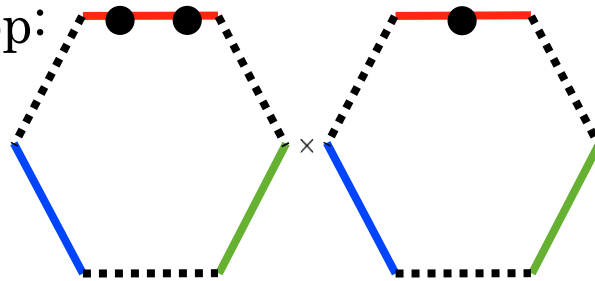

2-loop: No new contributions.

3-loop:

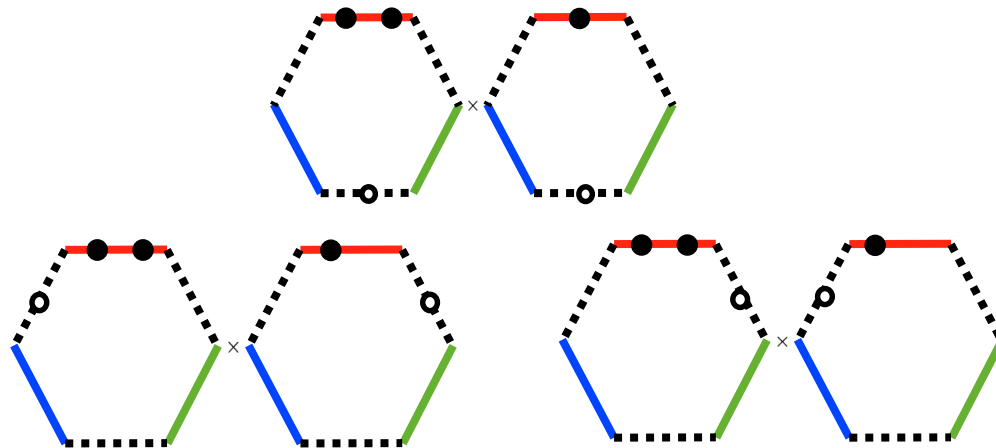

Virtual particle corrections

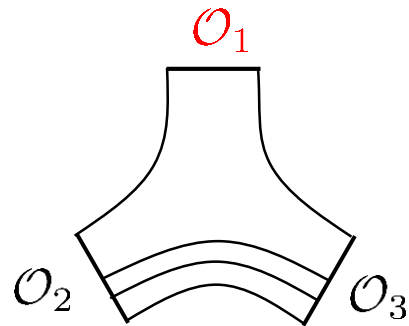

Tree-level and 1-loop:

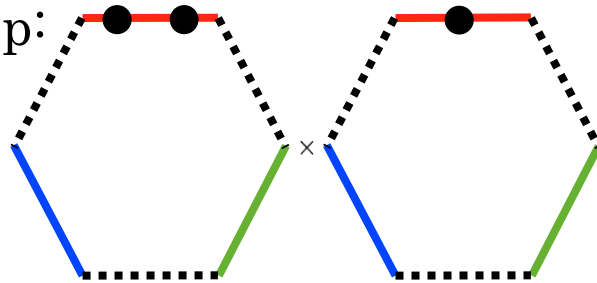

2-loop: No new contributions.

3-loop:

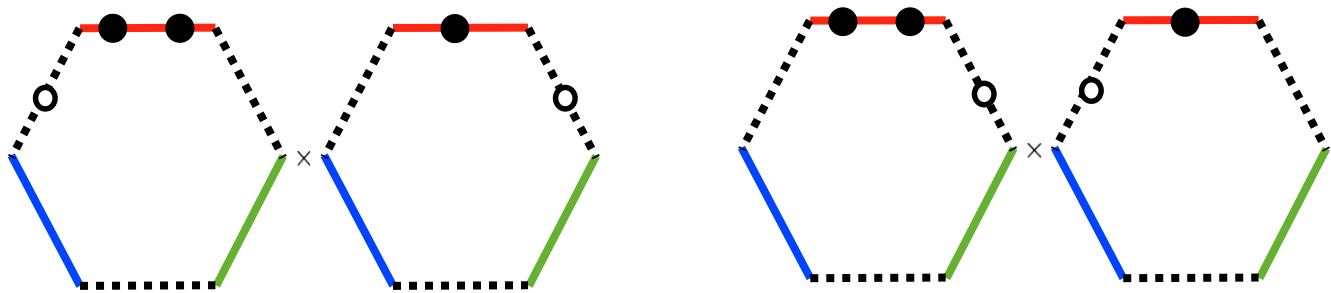

All our predictions agree with the recent 3-loop results

[Chicherin, Drummond, Heslop, Sokatchev] [Eden] (see also [Eden, Sfondrini])

Summary

- Non-perturbative approach to study 3pt functions:
 $3\text{pt} = \text{Hexagon}^2$
- Complete agreement with 3-loop data.
- Agreement with the strong coupling result (minimal surface in AdS) [[Kazama, SK](#)]

Future directions

1. 4-loop

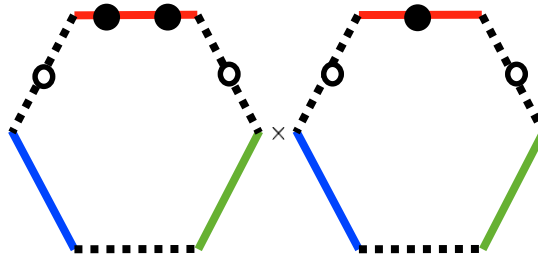

2. 4-point function from hexagons?

3. Resumming virtual particles?

Reproducing the strong coupling result? TBA, QSC for 3pt?

4. Other theories?

ABJM? 4d N=2?

[Pomoni, Mitev]