

Exotic Brane Junctions from **F**-theory

arXiv:1602.08606

accepted for publication in JHEP

Tetsuji KIMURA

Keio University & Tokyo Institute of Technology

F-theory

- ✓ IIB string theory; $SL(2, \mathbb{Z})$ S-duality
- ✓ $[p, q]$ 7-brane on which (p, q) -string is ending
- ✓ monodromy; branch cut and string junctions
→ non-trivial gauge/flavor symmetries

$[1, 0]$ 7-brane = D7-brane

$[0, 1]$ 7-brane = “NS7-brane” or 7_3 -brane

Exotic branes

- ✓ from standard branes via string dualities in lower dim
- ✓ codim = 2 \rightarrow **monodromy** by string dualities

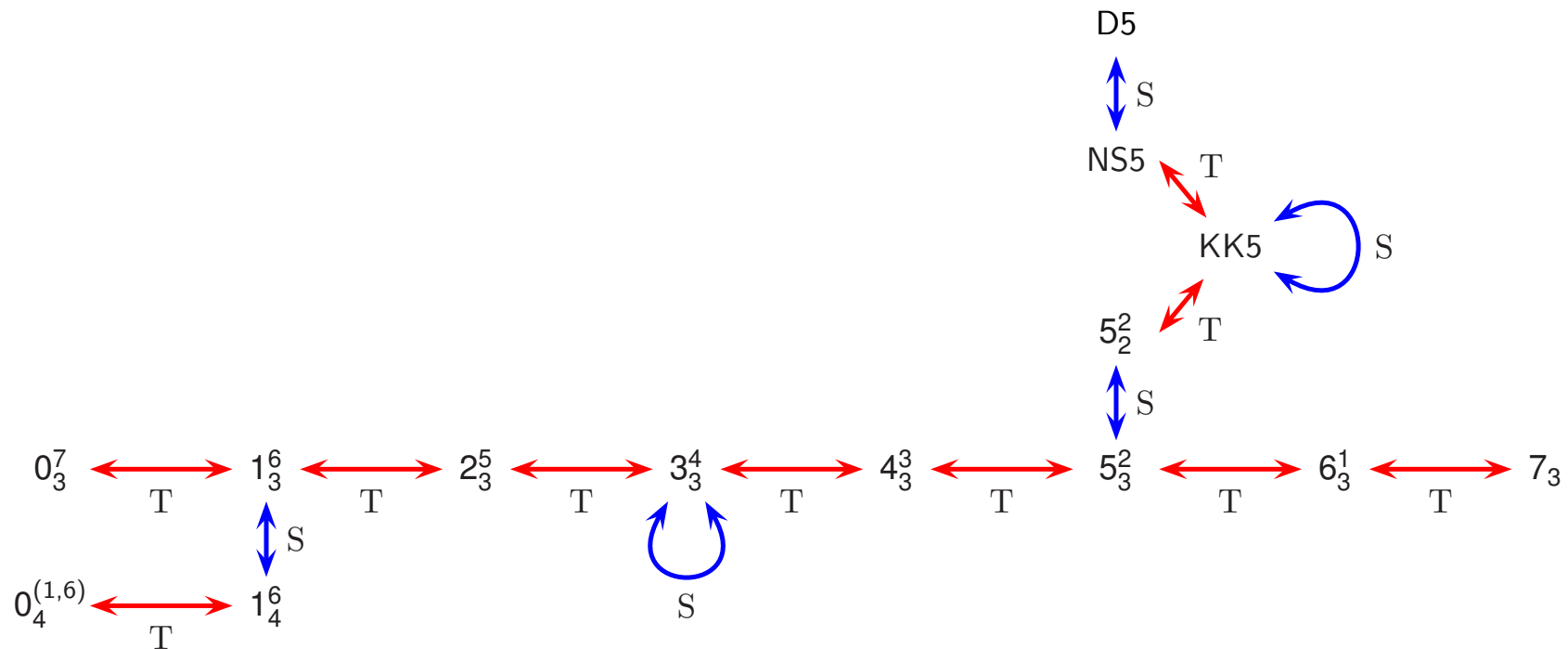

Contents

- ✓ F-theory
- ✓ Exotic brane junctions
- ✓ SCFTs with E_{n+1} symmetry in 5D, 4D, 3D
- ✓ Summary

F-theory

Vafa, “Evidence for F-theory” : [hep-th/9602022](#)

Zwiebach et al: [hep-th/9709013](#), [9801205](#), [9804210](#), [9812028](#), [9812209](#), etc.

Zwiebach: “Seven-brane, string junctions and Lie algebra,” 1998年国際シンポジウム「ゲージ理論の力学と弦双対性」

DeWolfe, Hanany, Iqbal and Katz: [hep-th/9902179](#)

IIB action in Einstein frame :

$$S_{\text{IIB}} = \frac{1}{2\kappa^2} \int d^{10}x \sqrt{-G_E} \left\{ R_E - \frac{\partial_M \bar{\rho} \partial^M \rho}{2(\rho_2)^2} - \frac{1}{2} F_{(3)}^i \cdot \mathcal{M}_{ij} F_{(3)}^j - \frac{1}{4} |\tilde{F}_{(5)}|^2 \right\} - \frac{\epsilon_{ij}}{8\kappa^2} \int C_{(4)} \wedge F_{(3)}^i \wedge F_{(3)}^j$$

$$\rho \equiv C + i e^{-\phi} \equiv \rho_1 + i \rho_2, \quad \mathcal{M}_{ij} \equiv \frac{1}{\rho_2} \begin{pmatrix} 1 & -\rho_1 \\ -\rho_1 & |\rho|^2 \end{pmatrix}$$

$$F_{(3)}^i \equiv \begin{pmatrix} dC_{(2)} \\ dB_{(2)} \end{pmatrix}, \quad \tilde{F}_{(5)} \equiv dC_{(4)} - \frac{1}{2} C_{(2)} \wedge H_{(3)} + \frac{1}{2} B_{(2)} \wedge F_{(3)}$$

$SL(2, \mathbb{Z})$ S-duality

$$\rho \rightarrow \frac{a\rho + b}{c\rho + d}, \quad \Lambda^i_j = \begin{pmatrix} a & b \\ c & d \end{pmatrix} \in SL(2, \mathbb{Z})$$

$$F_{(3)}^i \rightarrow \Lambda^i_j F_{(3)}^j, \quad \tilde{F}_{(5)} \rightarrow \tilde{F}_{(5)}, \quad G_{MN}^E \rightarrow G_{MN}^E$$

$$\mathcal{M} \rightarrow \Lambda^{-T} \mathcal{M} \Lambda^{-1}$$

F-string : couple to $B_{(2)}$

D-string : couple to $C_{(2)}$

D7-brane : (magnetically) couple to $C \in \rho(z)$

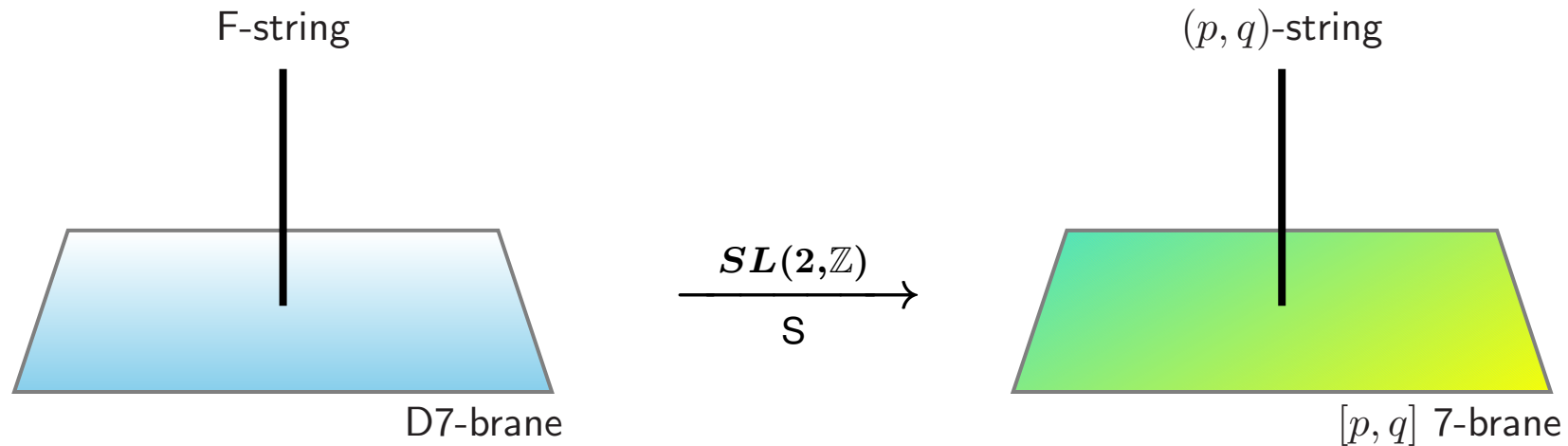

$(1, 0)$ -string = F-string

$(0, 1)$ -string = D-string

$[1, 0]$ 7-brane = D7-brane

$[0, 1]$ 7-brane = **7₃-brane** (or NS7-brane)

When ρ moves around D7-brane counterclockwise,
 it receives a magnetic “charge” of D7-brane (**monodromy**) $\rightarrow \rho + 1$

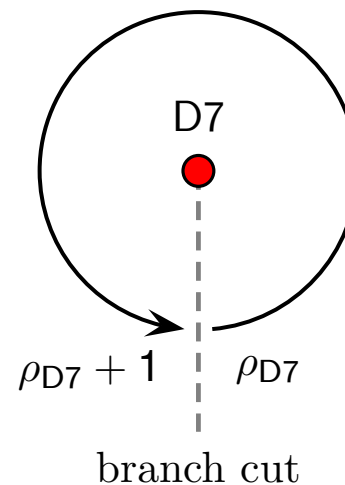

$$\rho \rightarrow \rho + 1 = \frac{a\rho + b}{c\rho + d} \equiv M_{[1,0]} \cdot \rho, \quad M_{[1,0]} = \begin{pmatrix} 1 & 1 \\ 0 & 1 \end{pmatrix} \in SL(2, \mathbb{Z})$$

or equivalently

$$K_{[1,0]} \cdot (\rho + 1) = \rho, \quad K_{[1,0]} = (M_{[1,0]})^{-1} = \begin{pmatrix} 1 & -1 \\ 0 & 1 \end{pmatrix}$$

Monodromy matrix $K_{[1,0]}$ is $SL(2, \mathbb{Z})$ transformed to $K_{[p,q]}$ for $[p, q]$ 7-brane :

$$\begin{pmatrix} 1 \\ 0 \end{pmatrix} \rightarrow g \begin{pmatrix} 1 \\ 0 \end{pmatrix} = \begin{pmatrix} p \\ q \end{pmatrix}, \quad g = \begin{pmatrix} p & r \\ q & s \end{pmatrix} \in SL(2, \mathbb{Z})$$

$$K_{[p,q]} = g K_{[1,0]} g^{-1} = \begin{pmatrix} 1 + pq & -p^2 \\ q^2 & 1 - pq \end{pmatrix}$$

ex) monodromy $K_{[0,1]}$ for 7_3 -brane : $K_{[0,1]} = \begin{pmatrix} 1 & 0 \\ 1 & 1 \end{pmatrix}$

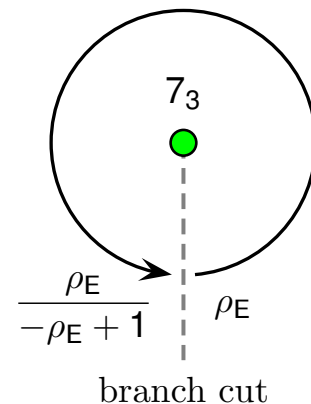

$$\rho_E = -\frac{1}{\rho_{D7}}$$

(r, s) -string crossing the branch cut of $[p, q]$ 7-brane :



w/ charge conservation law : $qr - ps = \pm 1$

“ $[p, q]_7^S$ ” means $[p, q]$ 7-brane

(r, s) 5-brane crossing the branch cut of $[p, q]$ 7-brane :



w/ charge conservation law : $qr - ps = \pm 1$

$(p, q)_5$ -brane : p D5-branes + q NS5-branes on which (p, q) -string is ending

Exotic brane junctions

Nomenclature $b_n^{(d,c)}$:

$$\text{tension} = \frac{R_1 R_2 \cdots R_b (R_{b+1} \cdots R_{b+c})^2 (R_{b+c+1} \cdots R_{b+c+d})^3}{g_s^n \ell_s^{b+2c+3d+1}}$$

String dualities

$$\mathbf{T}_y : R_y \rightarrow \frac{\ell_s^2}{R_y}, \quad g_s \rightarrow \frac{\ell_s}{R_y} g_s$$

$$\mathbf{S} : g_s \rightarrow \frac{1}{g_s}, \quad \ell_s \rightarrow g_s^{1/2} \ell_s$$

$$D5(12345) \xrightarrow{\mathbf{S}} NS5(12345) \xrightarrow{\mathbf{T}_9} KK5(12345,9) \xrightarrow{\mathbf{T}_8} 5_2^2(12345,89) \xrightarrow{\mathbf{S}} 5_3^2(12345,89)$$

5_1 5_2 5_2^1

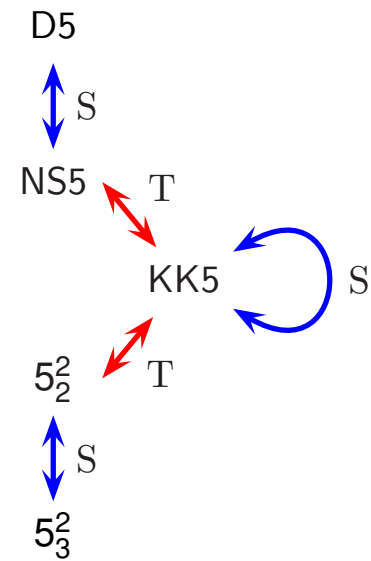

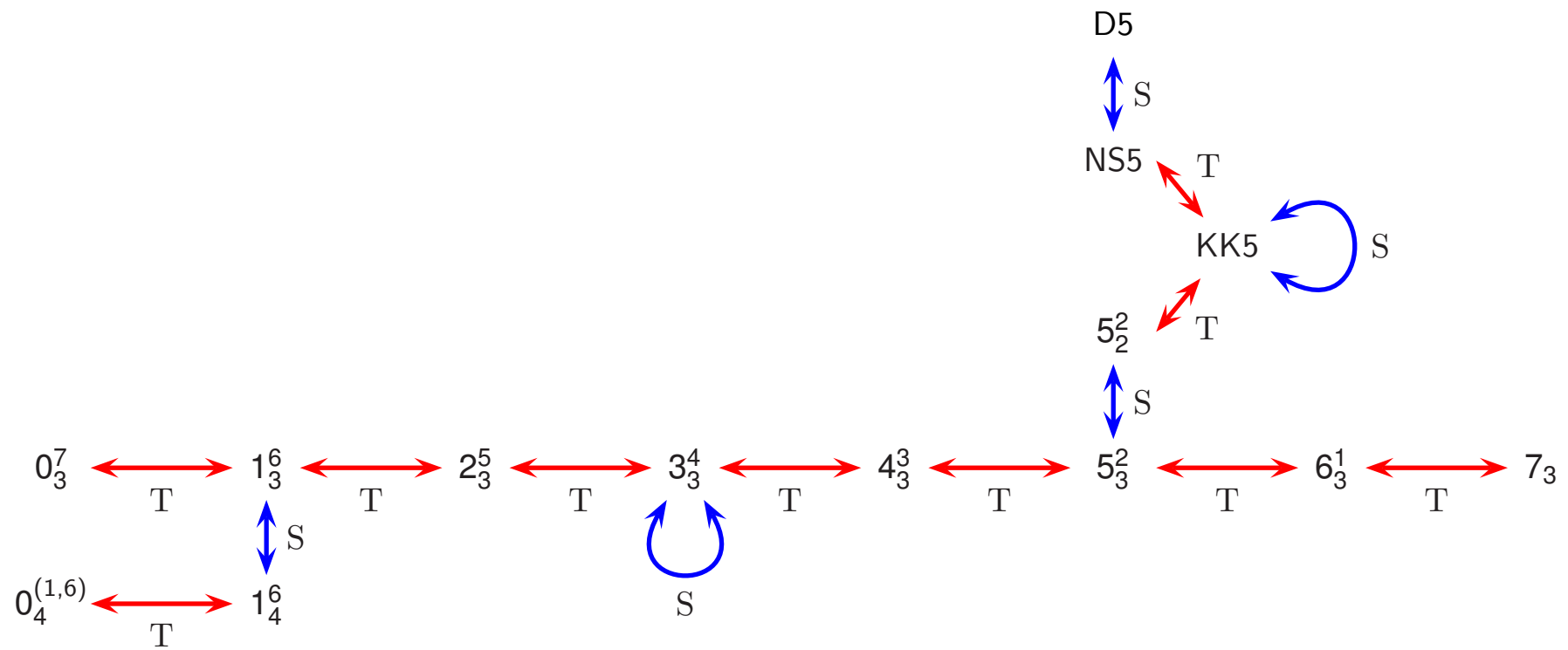

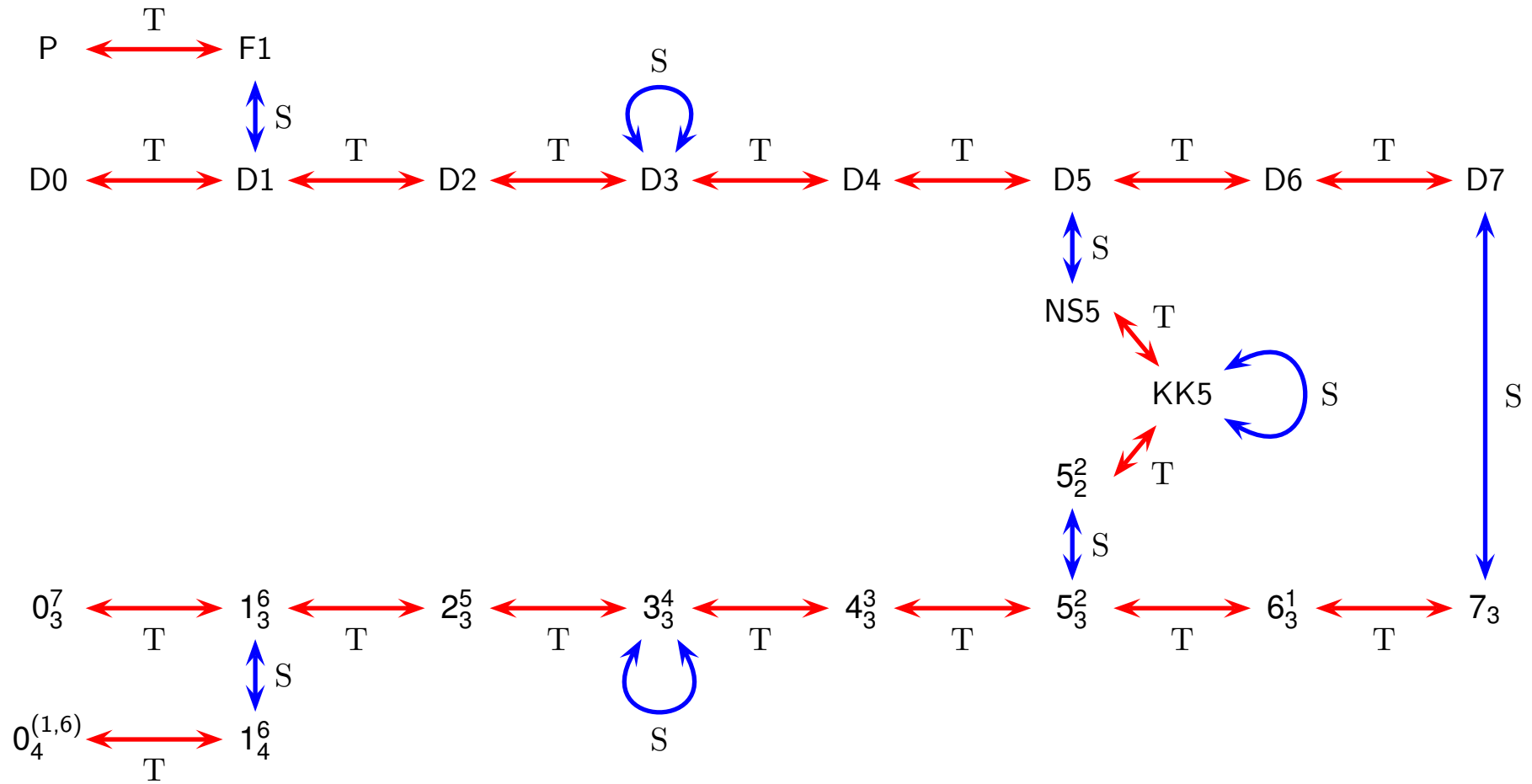

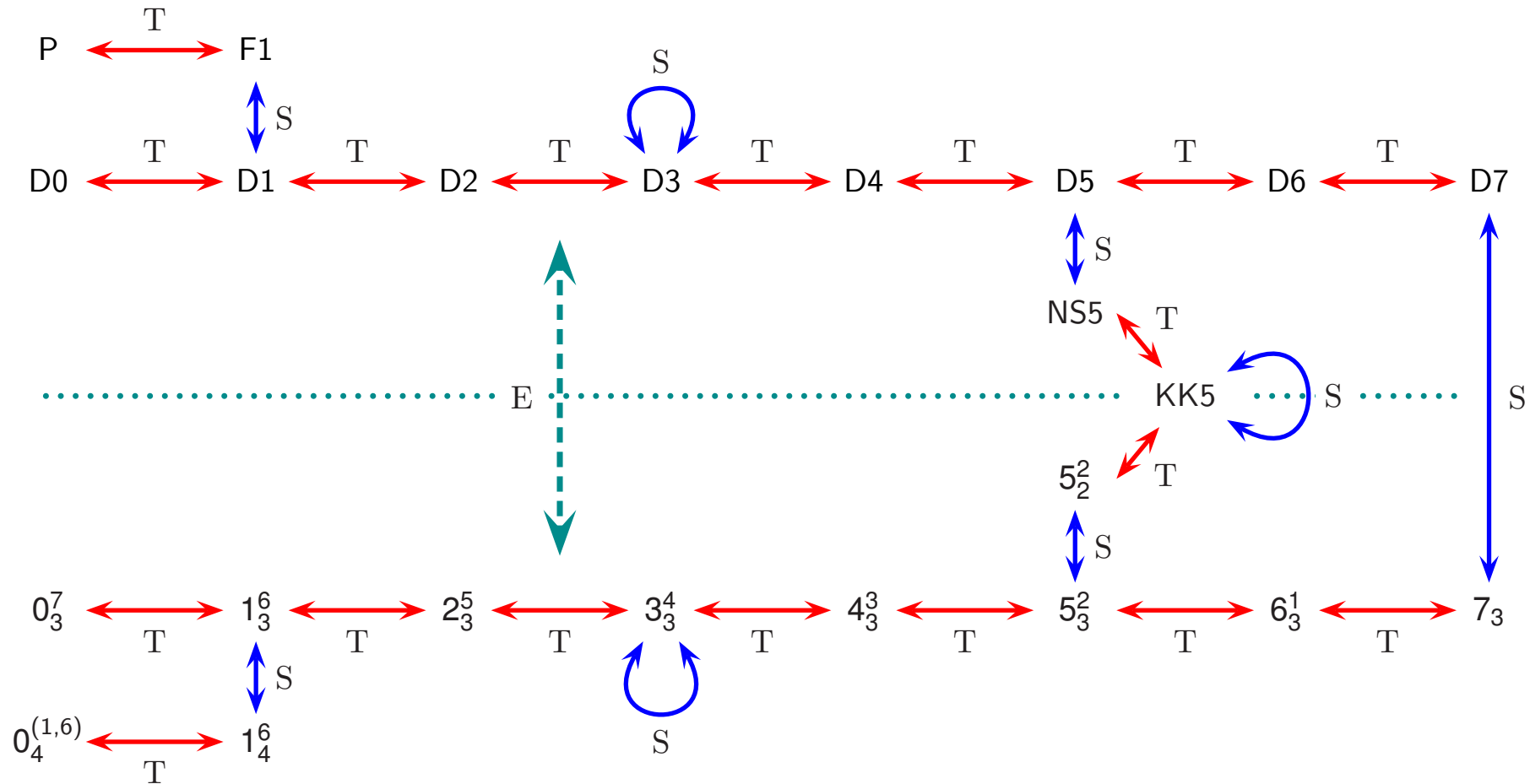

The $SL(2, \mathbb{Z})$ pairs (Dp, p_3^{7-p}) , $(NS5, 5_3^2)$, $(F1, 1_4^6)$, $(P, 0_4^{(1,6)})$ yield **the same physics** as that of $(D7, 7_3)$.

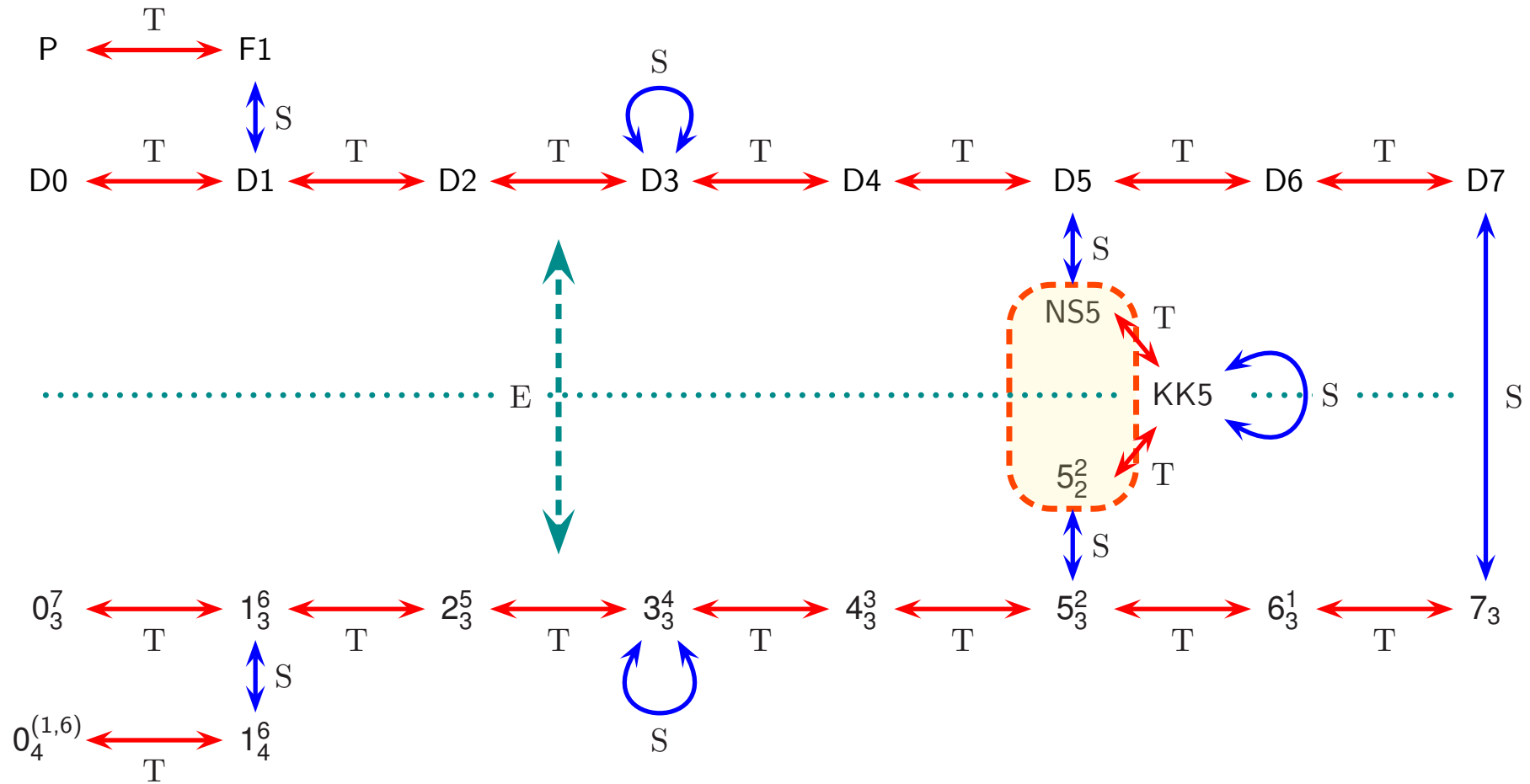

We focus on $[p, q]_{s5}^T$ -brane = $(p \text{ NS5}, q \text{ } 5_2^2)$.

F-string : couple to $B_{(2)}$

D-string : couple to $C_{(2)}$

D7(1234567) : couple to $\rho(z) = C + ie^{-\phi}$ ($z = x^8 + ix^9$)

F-theory

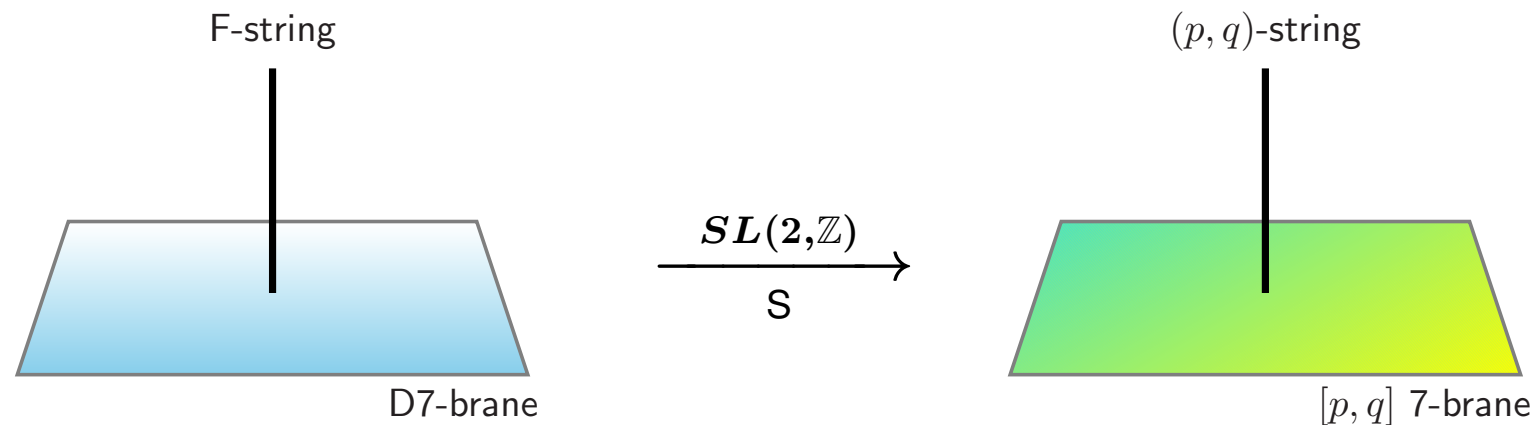

$(1, 0)$ -string = F1

$[1, 0]$ 7-brane = D7(1234567)

$(0, 1)$ -string = D1

$[0, 1]$ 7-brane = $7_3(1234567)$

Open D-string is ending on $7_3(1234567)$.

D-string : couple to $C_{(2)}$

D3-brane : couple to $C_{(4)}$

NS5(12345) : couple to $\rho(z) = B_{67}^{(2)} + ie^{+2\phi} \quad (z = x^8 + ix^9)$

ST₆₇-dualized

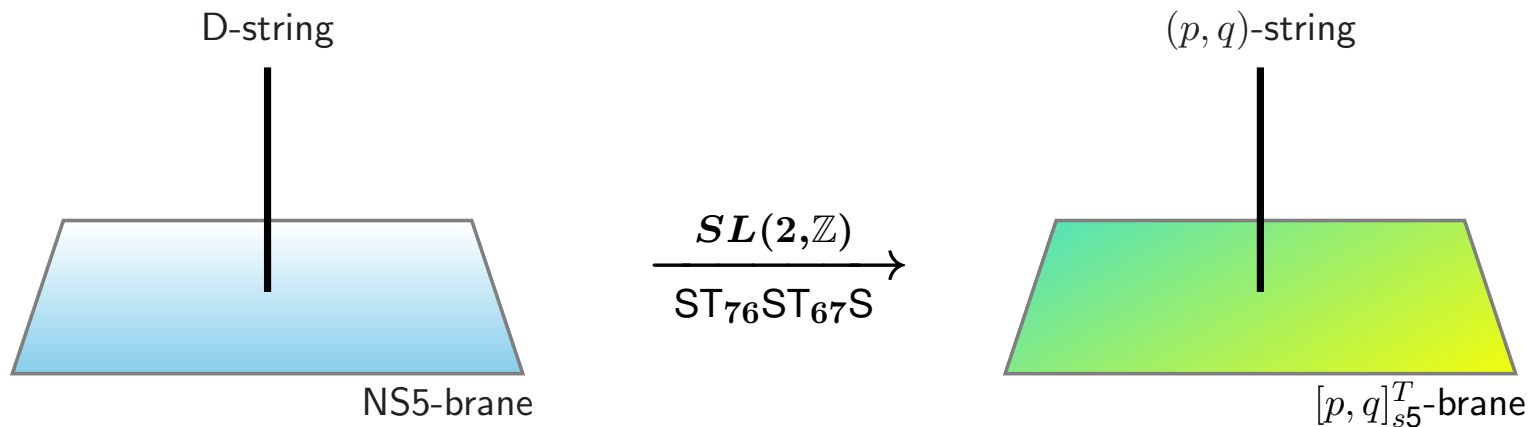

$(1, 0)$ -string = D1

$(0, 1)$ -string = D3 wrapped on T_{67}^2

$[1, 0]_{S^5}^T$ -brane = NS5(12345)

$[0, 1]_{S^5}^T$ -brane = $5_2^2(12345, 67)$

Open D3-brane wrapped on T_{67}^2 is ending on $5_2^2(12345, 67)$.

When ρ moves around exotic 5-brane in 8D,
it receives a magnetic “charge” (monodromy)

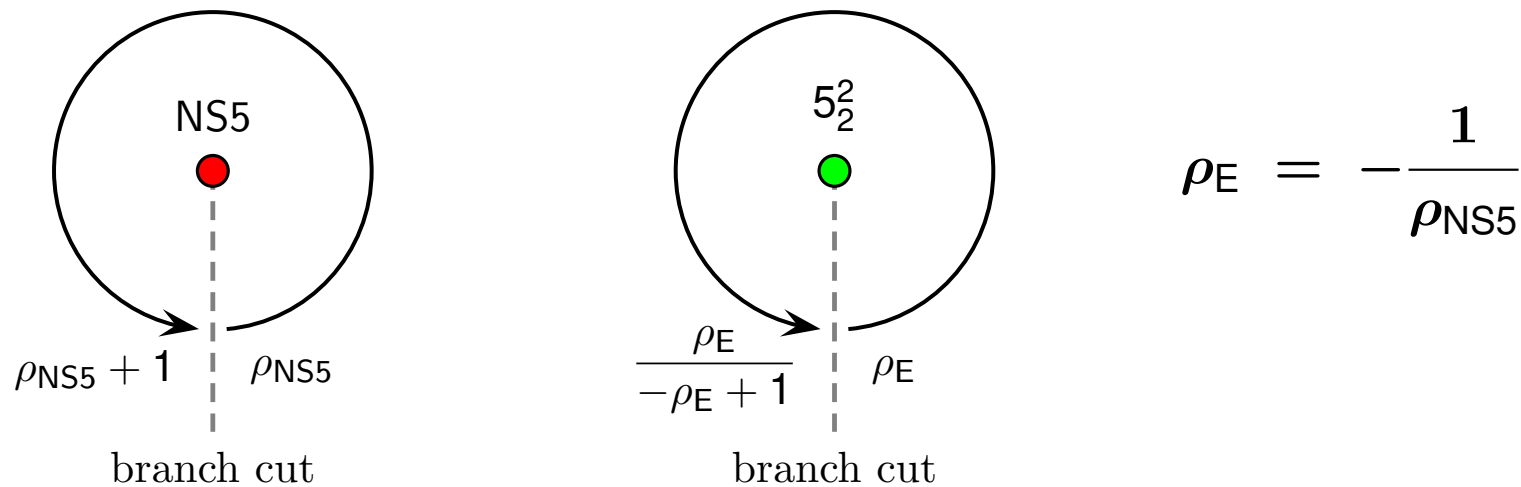

$$\rho \rightarrow M_{[p,q]_{s5}^T} \cdot \rho, \quad K_{[p,q]_{s5}^T} = (M_{[p,q]_{s5}^T})^{-1} = \begin{pmatrix} 1 + pq & -p^2 \\ q^2 & 1 - pq \end{pmatrix} \in SL(2, \mathbb{Z})$$

$$\text{monodromy matrix : } K_{[p,q]_{s5}^T} = K_{[p,q]_7^S}$$

(r, s) -string crossing the branch cut of $[p, q]_{s5}^T$ -brane :

(p, q) -string : p D1 + q D3 wrapped on T_{67}^2

i.e., ST_{67} -dual of original (p, q) -string = p F1 + q D1

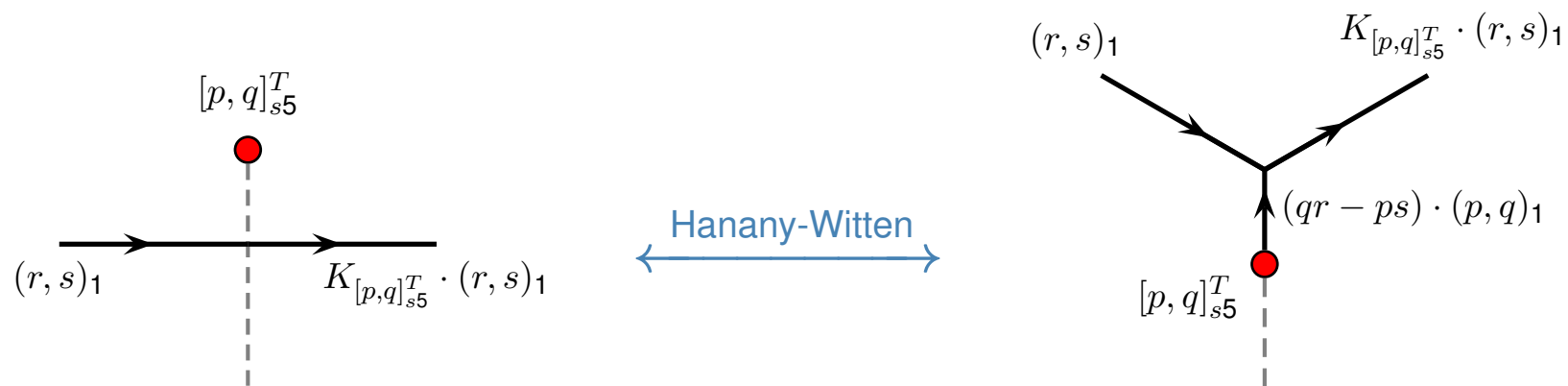

D3-brane wrapped on T_{67}^2 is ending on $5_2^2(12345,67)$.

(r, s) 5-brane crossing the branch cut of $[p, q]_{s5}^T$ -brane :

(p, q) 5-brane : p $7_3(123467X)$ wrapped on $T_{67}^2 + q$ $5_3^2(1234Y,67)$

i.e., ST_{67} -dual of original (p, q) 5-brane = p D5(1234X) + q NS5(1234Y)



$5_3^2(1234Y,67)$ is ending on $5_2^2(12345,67)$.

(r, s) 4-brane crossing the branch cut of $[p, q]_{s5}^T$ -brane :

(p, q) 4-brane : p NS5(1237X) wrapped on S_7^1 + q KK5(1234Y,7) wrapped on S_4^1

i.e., ST₄₇-dual of original (p, q) 5-brane = p D5(1234X) + q NS5(1234Y)



KK5(1234Y,7) wrapped on S_4^1 is ending on $5_2^2(12345,67)$.

(r, s) 3-brane crossing the branch cut of $[p, q]_{s5}^T$ -brane :

(p, q) 3-brane : p D3(12X) + q D5(1234Y) wrapped on T_{34}^2

i.e., ST_{34} -dual of original (p, q) 5-brane = p D5(1234X) + q NS5(1234Y)



D5(1234Y) wrapped on T_{34}^2 is ending on $5_2^2(12345, 67)$.

SCFTs with E_{n+1} symmetry in 5D, 4D, 3D

DeWolfe, Hanany, Iqbal and Katz: [hep-th/9902179](#)

Benini, Benvenuti and Tachikawa: [arXiv:0906.0359](#)

Kim, Taki and Yagi: [arXiv:1504.03672](#)

TK: [arXiv:1602.08606](#)

5D SUSY gauge theory by **brane construction** :

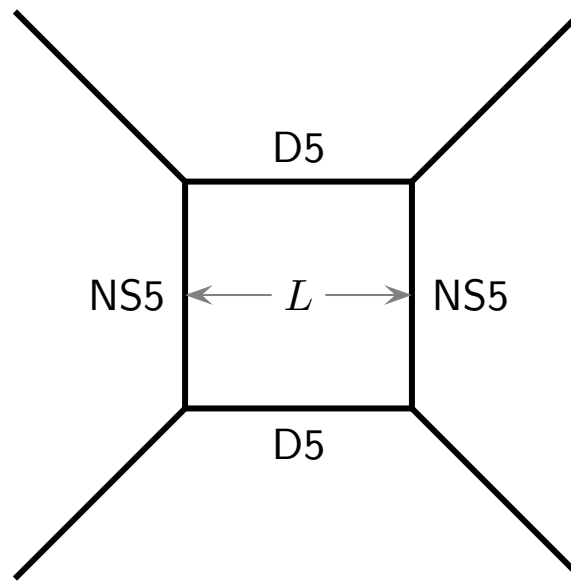

- ✓ N_c D5 between 2 NS5 = $SU(N_c)$ gauge symmetry
- ✓ N_f D5 outside 2 NS5 = N_f flavors
- ✓ $\frac{1}{g_{\text{YM}}^2} \simeq \frac{L}{g_s \ell_s^2}$

5D SUSY gauge theory by **brane construction** :

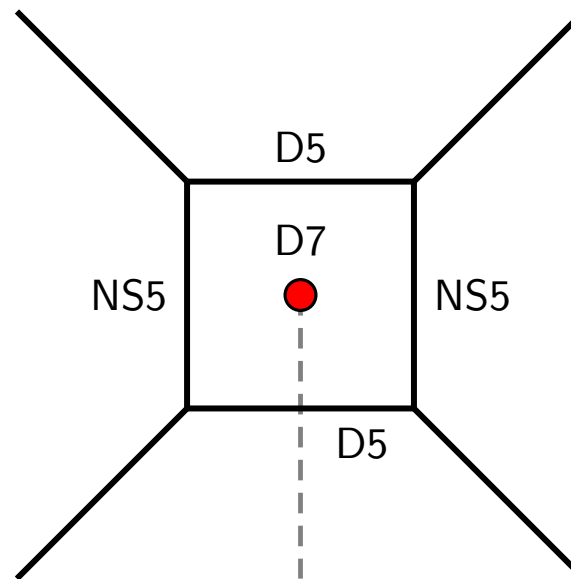

- ✓ N_c D5 between 2 NS5 = $SU(N_c)$ gauge symmetry
- ✓ N_f D5 outside 2 NS5 = N_f flavors
- ✓ $\frac{1}{g_{\text{YM}}^2} \simeq \frac{L}{g_s \ell_s^2}$

5D SUSY gauge theory by **brane construction** :

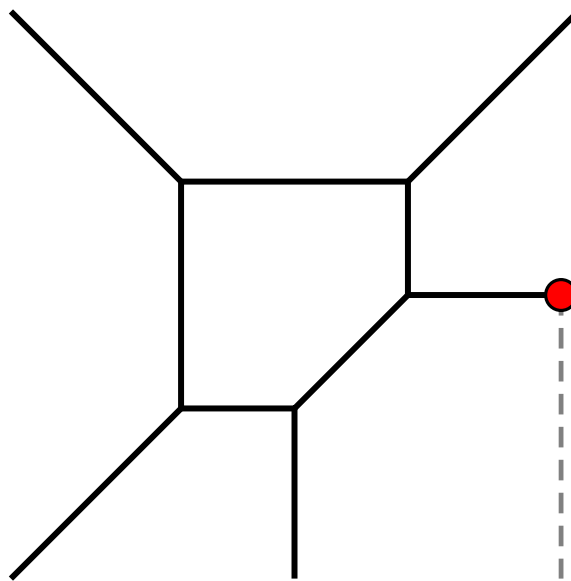

- ✓ N_c D5 between 2 NS5 = $SU(N_c)$ gauge symmetry
- ✓ N_f D5 outside 2 NS5 = N_f flavors
- ✓ $\frac{1}{g_{\text{YM}}^2} \simeq \frac{L}{g_s \ell_s^2}$

5D SUSY gauge theory by **brane construction** :

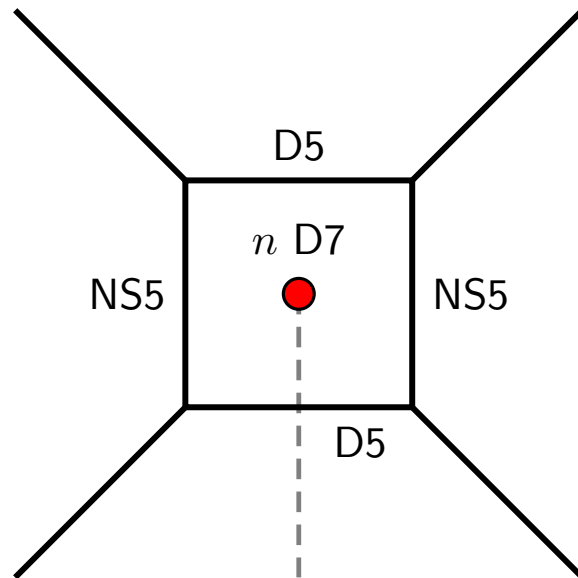

IIB		0	1	2	3	4	5	6	7	8	9
	n D7	—	—	—	—	—	—	—	—		
	D5	—	—	—	—	—				—	
	NS5	—	—	—	—	—					—
$(r, s)_5$	r D5	—	—	—	—	—				angle	
	s NS5	—	—	—	—	—				angle	

5D $SU(2)$ gauge symmetry with n flavors on 01234-directions

$L \rightarrow 0$ limit : SCFT with E_{n+1} symmetry

$n = 5, 6, 7$ D7-branes :

5D $\mathcal{N} = 1$ $SU(2)$ gauge theory w/ n flavors on D5-brane

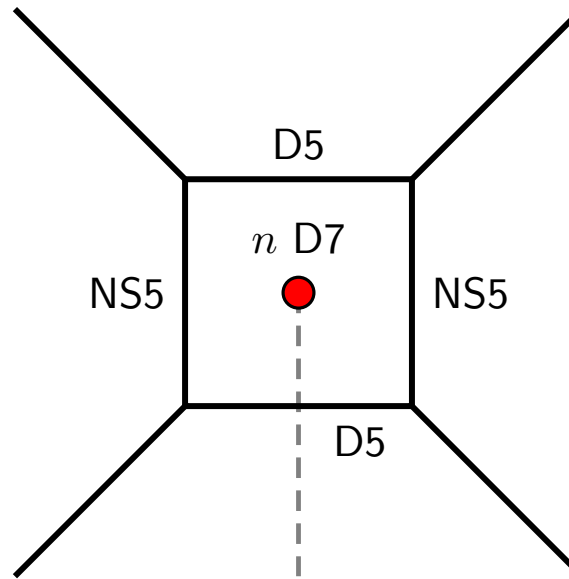

$n = 5, 6, 7$ D7-branes :

5D $\mathcal{N} = 1$ $SU(2)$ gauge theory w/ n flavors on D5-brane

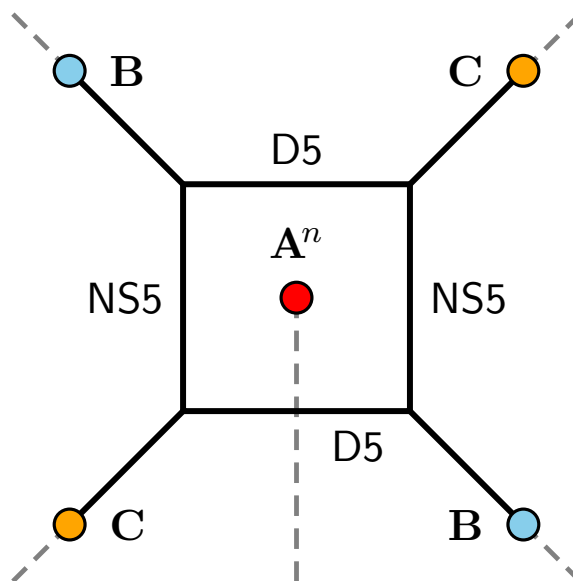

A-brane : $[1, 0]$ 7-brane = D7-brane

B-brane : $[1, -1]$ 7-brane

C-brane : $[1, 1]$ 7-brane

$n = 5, 6, 7$ D7-branes :

5D $\mathcal{N} = 1$ $SU(2)$ gauge theory w/ n flavors on D5-brane

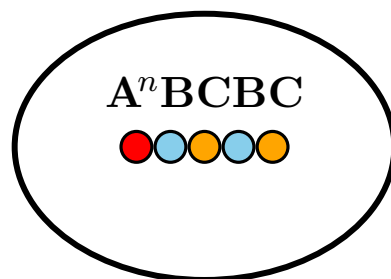

Hanany-Witten transitions

“Box” becomes “loop” by back reaction of $A^n BCBC$ -branes

$n = 5, 6, 7$ D7-branes :

5D $\mathcal{N} = 1$ $SU(2)$ gauge theory w/ n flavors on D5-brane

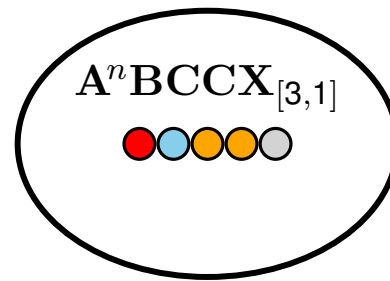

re-ordering of 7-branes : $A^n BCBC = A^n BCCX_{[3,1]}$

$X_{[3,1]}$ -brane \equiv $[3, 1]$ -brane

$n = 5, 6, 7$ D7-branes :

5D $\mathcal{N} = 1$ $SU(2)$ gauge theory w/ n flavors on D5-brane

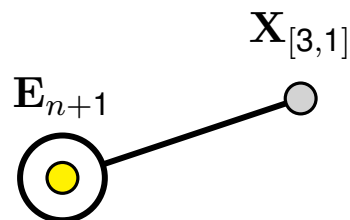

small loop limit = strong coupling limit, SCFT

A^n -, B -, and C^2 -branes are collapsed to E_{n+1} -brane.

$X_{[3,1]}$ -brane is gone far away from E_{n+1} -brane.

Open string ending on 5-brane loop and E_{n+1} -brane = E_{n+1} symmetry

5D SUSY gauge theory by **brane construction** :

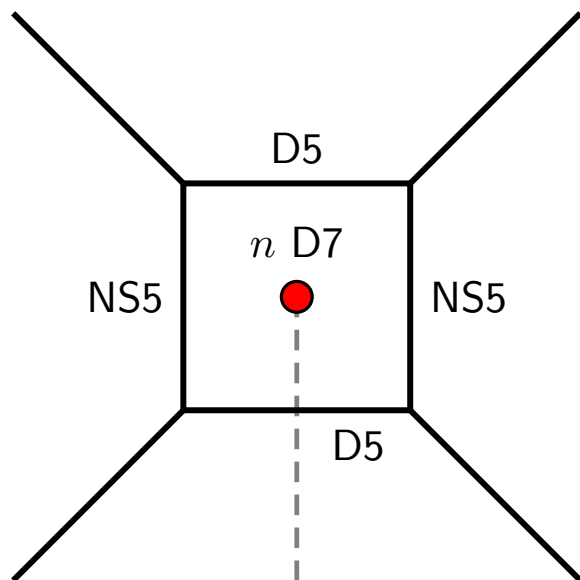

IIB		0	1	2	3	4	5	6	7	8	9
	n D7	-	-	-	-	-	-	-	-		
	D5	-	-	-	-	-				-	
	NS5	-	-	-	-	-					-
$(r, s)_5$	r D5	-	-	-	-	-				angle	
	s NS5	-	-	-	-	-				angle	

ST₆₇-dual → 5D

Perform string dualities : ST₄₇-dual → 4D

ST₃₄-dual → 3D

ST₆₇-dualized system :

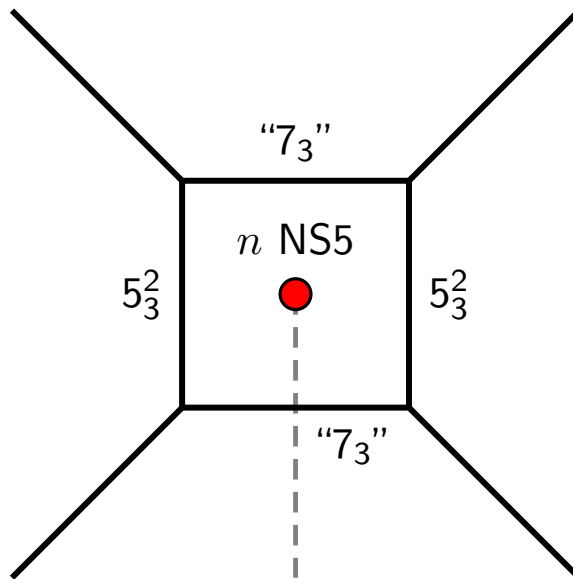

IIB		0	1	2	3	4	5	⑥	⑦	8	9
A^n	n NS5	—	—	—	—	—	—				
	"7 ₃ "	—	—	—	—	—		—	—	—	
	5_3^2	—	—	—	—	—		• ²	• ²		—
$(r, s)_5$	r "7 ₃ "	—	—	—	—	—		—	—	angle	
	s 5_3^2	—	—	—	—	—		• ²	• ²		

5D $SU(2)$ gauge symmetry with n flavors on 01234-directions

UV fixed point

ST₆₇-dualized system :

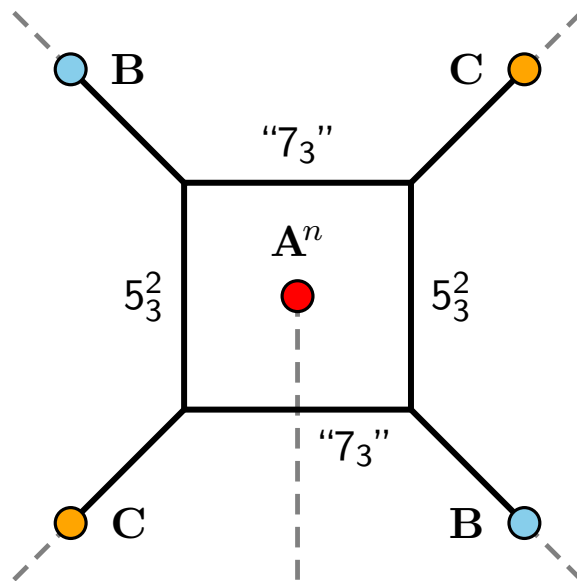

IIB		0	1	2	3	4	5	⑥	⑦	8	9
A^n	n NS5	—	—	—	—	—	—				
	"7 ₃ "	—	—	—	—	—		—	—	—	
	5_3^2	—	—	—	—	—		• ²	• ²		—
$(r, s)_5$	r "7 ₃ "	—	—	—	—	—		—	—	angle	
	s 5_3^2	—	—	—	—	—		• ²	• ²		

A-brane : $[1, 0]_{s5}^T$ -brane = NS5

B-brane : $[1, -1]_{s5}^T$ -brane

C-brane : $[1, 1]_{s5}^T$ -brane

5D $\mathcal{N} = 1$ $SU(2)$ gauge w/ n flavors \rightarrow SCFT w/ E_{n+1} symmetry

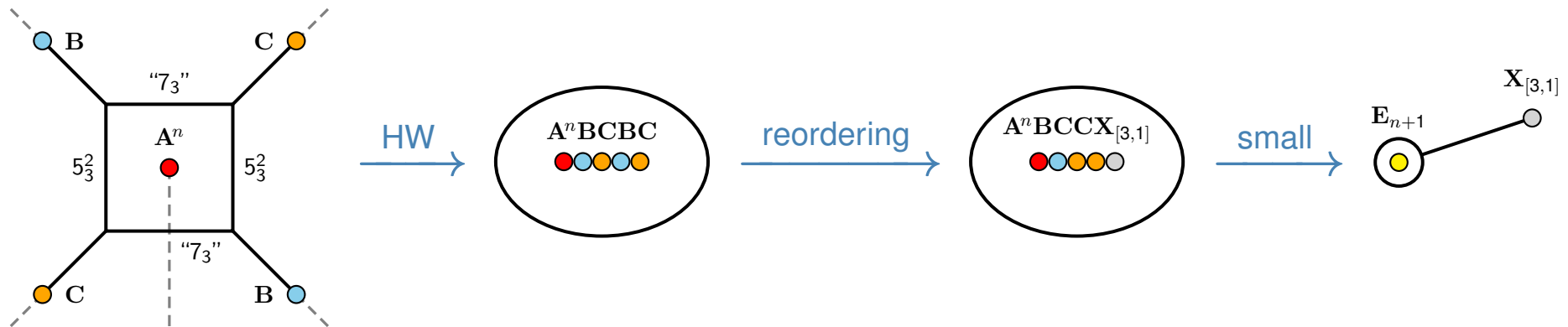

$n \geq 9$: no fixed point

gauge coupling on wrapped 7_3 :

$$\frac{1}{g_{\text{YM}}^2} \simeq \frac{V(T_{67}^2)L}{g_s \ell_s^4} = \frac{L}{g_s} \cdot \frac{2\pi \tilde{R}_6}{\ell_s^2} \cdot \frac{2\pi \tilde{R}_7}{\ell_s^2}$$

strong coupling limit :

$$\ell_s \rightarrow 0, \quad \frac{\tilde{R}_i}{\ell_s^2} \rightarrow 0, \quad L \rightarrow 0$$

ST₄₇-dualized system :

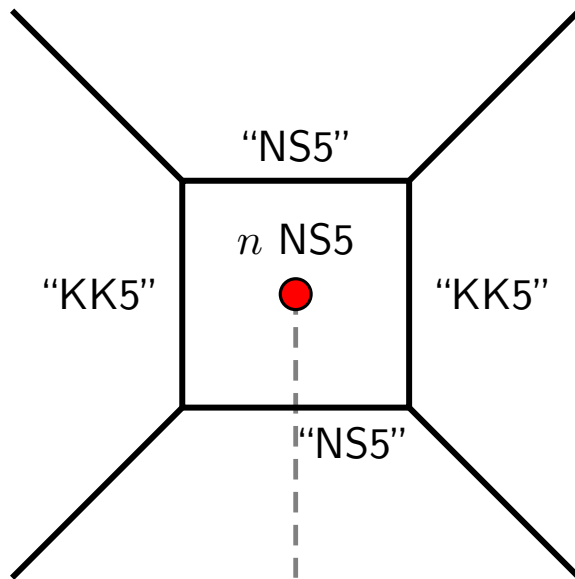

IIB		0	1	2	3	④	5	6	⑦	8	9
A^n	n NS5	—	—	—	—		—	—			
	“NS5”	—	—	—	—				—	—	
	“KK5”	—	—	—	—	—			• ²		—
$(r, s)_4$	r “NS5”	—	—	—	—				—		angle
	s “KK5”	—	—	—	—	—			• ²		

4D $SU(2)$ gauge symmetry with n flavors on 0123-directions

$$\beta(g_{\text{YM}}) = -\frac{4-n}{16\pi^2} g_{\text{YM}}^3 \rightarrow \begin{cases} 0 \leq n \leq 3 : & \text{IR fixed point} \\ n = 4 : & \text{conformal} \\ 5 \leq n \leq 8 : & \text{UV fixed point} \end{cases}$$

ST₄₇-dualized system :

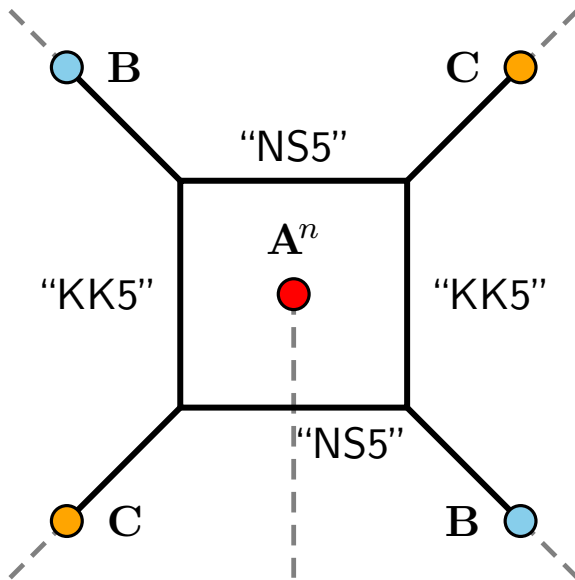

IIB		0	1	2	3	④	5	6	⑦	8	9
A^n	n NS5	—	—	—	—		—	—			
	"NS5"	—	—	—	—				—	—	
	"KK5"	—	—	—	—	—			• ²		—
$(r, s)_4$	r "NS5"	—	—	—	—				—	angle	
	s "KK5"	—	—	—	—	—			• ²		

A-brane : $[1, 0]_{s_5}^T$ -brane = NS5

B-brane : $[1, -1]_{s_5}^T$ -brane

C-brane : $[1, 1]_{s_5}^T$ -brane

4D $\mathcal{N} = 2$ $SU(2)$ gauge w/ n flavors \rightarrow SCFT w/ E_{n+1} symmetry

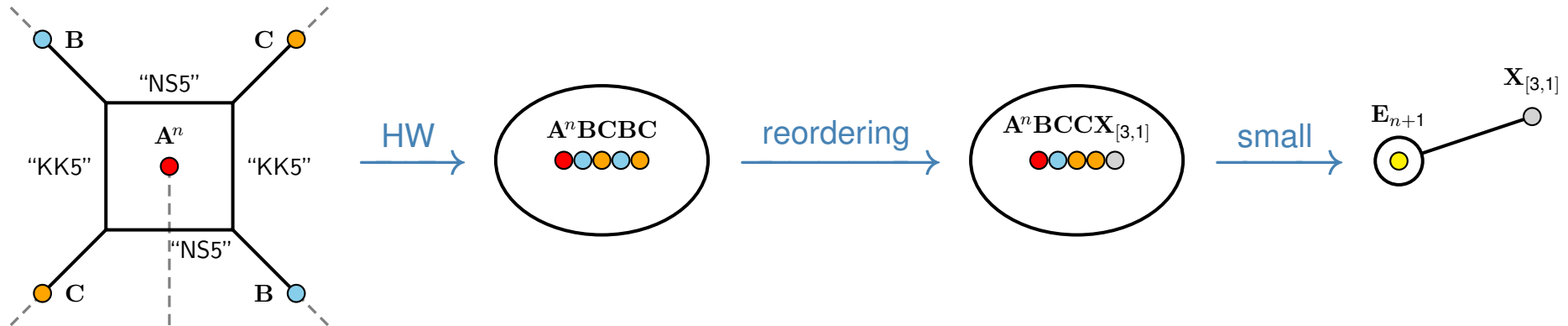

$n \geq 9$: no fixed point

gauge coupling on wrapped NS5 :

$$\frac{1}{g_{\text{YM}}^2} \simeq \frac{(2\pi \tilde{R}_7)L}{\ell_s^2}$$

strong coupling limit :

$$\ell_s \rightarrow 0, \quad \frac{\tilde{R}_7}{\ell_s^2} \rightarrow 0, \quad L \rightarrow 0$$

ST₃₄-dualized system :

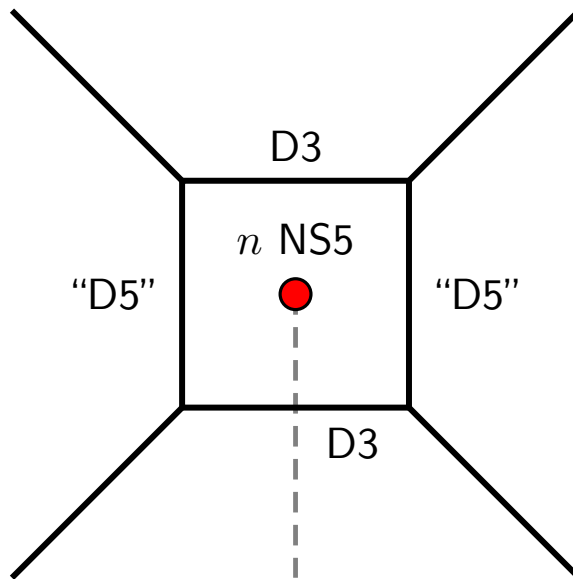

IIB		0	1	2	③	④	5	6	7	8	9
A^n	n NS5	—	—	—			—	—	—		
	D3	—	—	—						—	
	"D5"	—	—	—	—	—					—
$(r, s)_3$	r D3	—	—	—							
	s "D5"	—	—	—	—	—					angle

3D $SU(2)$ gauge symmetry with n flavors on 012-directions

IR fixed point

ST₃₄-dualized system :

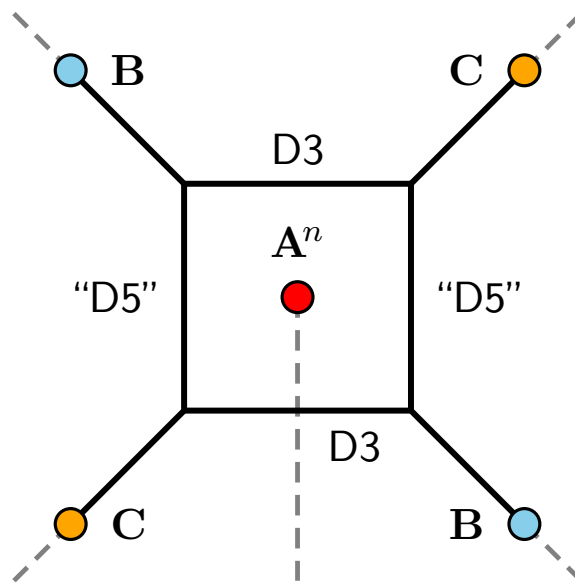

IIB		0	1	2	③	④	5	6	7	8	9
A^n	n NS5	—	—	—			—	—	—		
	D3	—	—	—						—	
	"D5"	—	—	—	—	—					—
$(r, s)_3$	r D3	—	—	—						angle	
	s "D5"	—	—	—	—	—					

A-brane : $[1, 0]_{s_5}^T$ -brane = NS5

B-brane : $[1, -1]_{s_5}^T$ -brane

C-brane : $[1, 1]_{s_5}^T$ -brane

3D $\mathcal{N} = 4$ $SU(2)$ gauge w/ n flavors \rightarrow SCFT w/ E_{n+1} symmetry

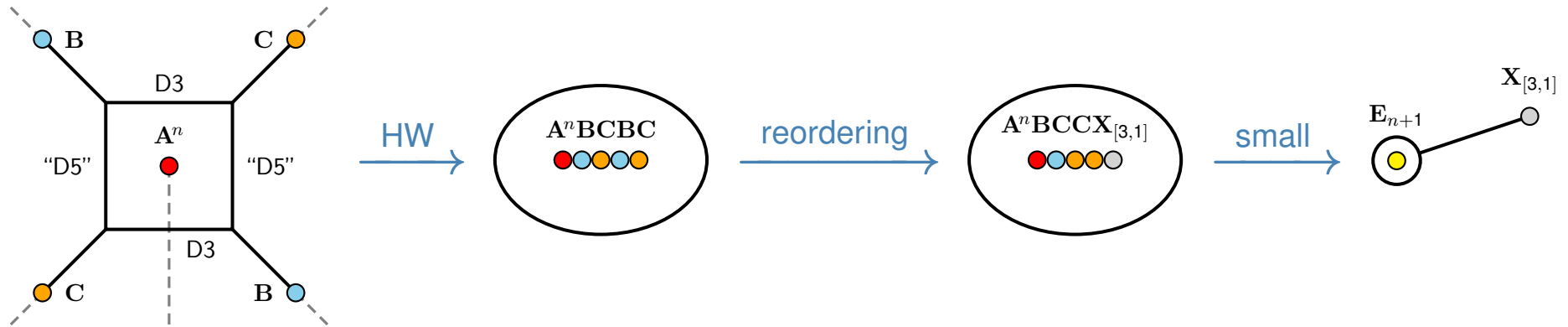

$n \geq 9$: no fixed point

gauge coupling on NS5 :

$$\frac{1}{g_{\text{YM}}^2} \simeq \frac{L}{g_s}$$

strong coupling limit :

$$L \rightarrow 0$$

Summary

Eventually, we **understood**

- ✓ objects ending on 5_2^2 -brane
= wrapped D3-brane

(Its oscillations provide excitation modes on the 5_2^2 -brane worldvolume.)

- ✓ objects sensitive to 5_2^2 -brane branch cut
= wrapped D3 (and 5_3^2 , wrapped KK5, wrapped D5)

(They are created/annihilated by the Hanany-Witten transitions.)

We also **found** the brane constructions which give rise to

- ✓ SCFTs with E_{n+1} symmetry in 5D, 4D, 3D (qualitatively)

We can further construct various brane configurations involving exotic branes.

Exotic F-theories

If you adapt the techniques of the 7-branes to the exotic branes,
you can construct F-theories in **any** dimensions.

Thanks

Appendix

- Solitonic five-branes in IIA theory :

$$\text{NS5}(12345) : \pm\epsilon = \Gamma^{012345}\epsilon$$

$$\text{KK5}(12345,9) : \pm\epsilon = \Gamma^{012345}\Gamma\epsilon$$

$$5_2^2(12345,89) : \pm\epsilon = \Gamma^{012345}\epsilon$$

$$5_2^3(12345,789) : \pm\epsilon = \Gamma^{012345}\Gamma\epsilon$$

$$5_2^4(12345,6789) : \pm\epsilon = \Gamma^{012345}\epsilon$$

Lozano-Tellechea and Ortín: hep-th/0012051

TK: arXiv:1601.02175

- Solitonic five-branes in IIB theory :

$$\text{NS5}(12345) : \pm\epsilon = \Gamma^{012345}(\sigma_3)\epsilon$$

$$\text{KK5}(12345,9) : \pm\epsilon = \Gamma^{012345}\epsilon$$

$$5_2^2(12345,89) : \pm\epsilon = \Gamma^{012345}(\sigma_3)\epsilon$$

$$5_2^3(12345,789) : \pm\epsilon = \Gamma^{012345}\epsilon$$

$$5_2^4(12345,6789) : \pm\epsilon = \Gamma^{012345}(\sigma_3)\epsilon$$

Lozano-Tellechea and Ortín: hep-th/0012051

TK: arXiv:1601.02175

- Defect branes in IIA theory :

$$6_3^1(123456,7) : \pm\epsilon = \Gamma^{0123456}(\sigma_1)\epsilon$$

$$4_3^3(1234,567) : \pm\epsilon = \Gamma^{01234}\Gamma(\sigma_1)\epsilon$$

$$2_3^5(12,34567) : \pm\epsilon = \Gamma^{012}(\sigma_1)\epsilon$$

$$0_3^7(,1234567) : \pm\epsilon = \Gamma^0\Gamma(\sigma_1)\epsilon$$

$$1_4^6(1,234567) : \pm\epsilon = \Gamma^{01}\Gamma\epsilon$$

$$0_4^{(1,6)}(,234567,1) : \pm\epsilon = \Gamma^{01}\epsilon$$

Lozano-Tellechea and Ortín: hep-th/0012051

TK: arXiv:1601.02175

- Defect branes in IIB theory :

$$7_3(1234567) : \pm\epsilon = \Gamma^{01234567}(\mathbf{i}\sigma_2)\epsilon$$

$$5_3^2(12345,67) : \pm\epsilon = \Gamma^{012345}(\sigma_1)\epsilon$$

$$3_3^4(123,4567) : \pm\epsilon = \Gamma^{0123}(\mathbf{i}\sigma_2)\epsilon$$

$$1_3^6(1,234567) : \pm\epsilon = \Gamma^{01}(\sigma_1)\epsilon$$

$$1_4^6(1,234567) : \pm\epsilon = \Gamma^{01}(\sigma_3)\epsilon$$

$$0_4^{(1,6)}(,234567,1) : \pm\epsilon = \Gamma^{01}\epsilon$$

Lozano-Tellechea and Ortín: hep-th/0012051

TK: arXiv:1601.02175

- NS5(12345) :

$$ds^2 = dx_{012345}^2 + \rho_2 dx_{67}^2 + \rho_2 |f|^2 dz d\bar{z}$$

$$e^{2\phi} = \rho_2$$

$$B_{(2)} = \rho_1 dx^6 \wedge dx^7, \quad B_{(6)} = \frac{1}{\rho_2} dx^0 \wedge dx^1 \wedge \dots \wedge dx^5$$

$$\rho = \rho_1 + i\rho_2 = B_{67}^{(2)} + ie^{2\phi} = B_{67}^{(2)} + i\sqrt{\det G_{mn}}$$

$$\tau = (\text{complex structure of } T_{67}^2) = i$$

$$f = 1, \quad m, n = 6, 7$$

- $5_2^2(12345,67)$:

$$ds'^2 = dx_{012345}^2 + \rho'_2 dx_{67}^2 + \rho'_2 |f'|^2 dzd\bar{z}$$

$$e^{2\phi'} = \rho'_2$$

$$B'_{(2)} = \rho'_1 dx^6 \wedge dx^7, \quad B'_{(6)} = \frac{1}{\rho'_2} dx^0 \wedge dx^1 \wedge \dots \wedge dx^5$$

$$\rho' = B'_{67}^{(2)} + ie^{2\phi'} = B'_{67}^{(2)} + i\sqrt{\det G'_{mn}} = -\frac{1}{\rho_{\text{NS5}}}$$

$$\rho'_1 = -\frac{\rho_1}{|\rho|^2}, \quad \rho'_2 = \frac{\rho_2}{|\rho|^2}$$

$$\tau' = (\text{complex structure of } \tilde{T}_{67}^2) = i = -\frac{1}{\tau_{\text{NS5}}}$$

$$\rho'_2 |f'|^2 = \rho_2 |f|^2, \quad m, n = 6, 7$$

- KK5(12345,7) smeared along 6-th direction :

$$ds^2 = dx_{012345}^2 + \tau_2 dx_6^2 + \frac{1}{\tau_2} (dx^7 - \tau_1 dx^6)^2 + \tau_2 |f|^2 dzd\bar{z}$$

$$e^{2\phi} = 1, \quad B_{(2)} = 0, \quad B_{(6)} = 0$$

$$\rho = B_{67}^{(2)} + i\sqrt{\det G_{mn}} = i$$

$$\tau = (\text{complex structure of } T_{67}^2) = \tau_1 + i\tau_2$$

$$f = 1, \quad m, n = 6, 7$$

- KK5(12345,6) smeared along 7-th direction :

$$ds'^2 = dx_{012345}^2 + \tau_2' dx_6^2 + \frac{1}{\tau_2'} (dx^7 - \tau_1' dx^6)^2 + \tau_2' |f'|^2 dz d\bar{z}$$

$$e^{2\phi'} = 1, \quad B'_{(2)} = 0, \quad B'_{(6)} = 0$$

$$\rho' = B'_{67}{}^{(2)} + i\sqrt{\det G'_{mn}} = i = -\frac{1}{\rho_{\text{KK5}}}$$

$$\tau' = (\text{complex structure of } \tilde{T}_{67}^2) = \tau_1' + i\tau_2' = -\frac{1}{\tau_{\text{KK5}}}$$

$$\tau_2' |f'|^2 = \tau_2 |f|^2, \quad m, n = 6, 7$$

- $Dp(12 \cdots p)$:

$$ds^2 = \frac{1}{(\rho_2)^{1/2}} dx_{012 \cdots p}^2 + (\rho_2)^{1/2} dx_{a_1 \cdots a_{7-p}}^2 + (\rho_2)^{1/2} |f|^2 dz d\bar{z}$$

$$e^{2\phi} = (\rho_2)^{\frac{3-p}{2}}$$

$$C_{(7-p)} = \rho_1 dx^{a_1} \wedge \cdots \wedge dx^{a_{7-p}}$$

$$C_{(p+1)} = -\frac{1}{\rho_2} dx^0 \wedge dx^1 \wedge \cdots \wedge dx^p$$

$$\rho = C_{a_1 \cdots a_{7-p}}^{(7-p)} + ie^{\frac{4}{3-p}\phi} = C_{a_1 \cdots a_{7-p}}^{(7-p)} + ie^{-\phi} (\det G_{mn})^{1/2}$$

$$f = 1, \quad m, n = a_1, \dots, a_{7-p}$$

- $p_3^{7-p}(12 \cdots p, a_1 \cdots a_{7-p})$:

$$ds'^2 = \frac{1}{(\rho'_2)^{1/2}} dx_{012 \cdots p}^2 + (\rho'_2)^{1/2} dx_{a_1 \cdots a_{7-p}}^2 + (\rho'_2)^{1/2} |f'|^2 dz d\bar{z}$$

$$e^{2\phi'} = (\rho'_2)^{\frac{3-p}{2}}$$

$$C'_{(7-p)} = \rho'_1 dx^{a_1} \wedge \cdots \wedge dx^{a_{7-p}}, \quad C'_{(p+1)} = -\frac{1}{\rho'_2} dx^0 \wedge dx^1 \wedge \cdots \wedge dx^p$$

$$\rho' = C'_{a_1 \cdots a_{7-p}}^{(7-p)} + i e^{\frac{4}{3-p}\phi'} = -\frac{1}{\rho_{Dp}}$$

$$\rho'_1 = -\frac{\rho_1}{|\rho|^2}, \quad \rho'_2 = \frac{\rho_2}{|\rho|^2}$$

$$\rho'_2 |f'|^2 = \rho_2 |f|^2, \quad |f'| = |\rho| |f|, \quad m, n = a_1, \dots, a_{7-p}$$

- F1(1) :

$$ds^2 = \frac{1}{\rho_2} dx_{01}^2 + dx_{234567}^2 + |f|^2 dz d\bar{z}$$

$$e^{2\phi} = \frac{1}{\rho_2}$$

$$B_{(6)} = \rho_1 dx^2 \wedge dx^3 \wedge \cdots \wedge dx^7, \quad B_{(2)} = -\frac{1}{\rho_2} dx^0 \wedge dx^1$$

$$\rho = B_{234567}^{(6)} + ie^{-2\phi}, \quad f = 1$$

- $1_4^6(1,234567)$:

$$ds'^2 = \frac{1}{\rho'_2} dx_{01}^2 + dx_{234567}^2 + |f'|^2 dzd\bar{z}$$

$$e^{2\phi'} = \frac{1}{\rho'_2}$$

$$B'_{(6)} = \rho'_1 dx^2 \wedge dx^3 \wedge \cdots \wedge dx^7, \quad B'_{(2)} = -\frac{1}{\rho'_2} dx^0 \wedge dx^1$$

$$\rho' = B'^{(6)}_{234567} + ie^{-2\phi'} = -\frac{1}{\rho_{F1}}$$

$$\rho'_2 |f'|^2 = \rho_2 |f|^2, \quad |f'| = |\rho| |f|$$

- P(1) :

$$ds^2 = -2dx^0 dx^1 + \rho_2 dx_1^2 + dx_{234567}^2 + |f|^2 dz d\bar{z}$$

$$e^{2\phi} = \frac{1}{\rho_2}, \quad B_{(2)} = 0, \quad B_{(6)} = 0$$

$$\rho = ie^{-2\phi}, \quad f = 1$$

- $0_4^{(1,6)}(,234567,1)$:

$$ds^2 = -2dx^0 dx^1 + \rho'_2 dx_1^2 + dx_{234567}^2 + |f'|^2 dz d\bar{z}$$

$$e^{2\phi'} = \frac{1}{\rho'_2} = \frac{|\rho|^2}{\rho_2}, \quad B'_{(2)} = 0, \quad B'_{(6)} = 0$$

$$\rho' = ie^{-2\phi'} = -\frac{1}{\rho_P}, \quad \rho'_2 |f'|^2 = \rho_2 |f|^2, \quad |f'| = |\rho| |f|$$

$|\text{tr}K|$ is a good character to classify 7-branes :

$$K \cdot \rho_* = \frac{a\rho_* + b}{c\rho_* + d} = \rho_*, \quad K = \begin{pmatrix} a & b \\ c & d \end{pmatrix} \in SL(2, \mathbb{Z})$$

$$\therefore \rho_* = \frac{1}{2c} \left\{ (a - d) \pm \sqrt{(\text{tr}K)^2 - 4} \right\}$$

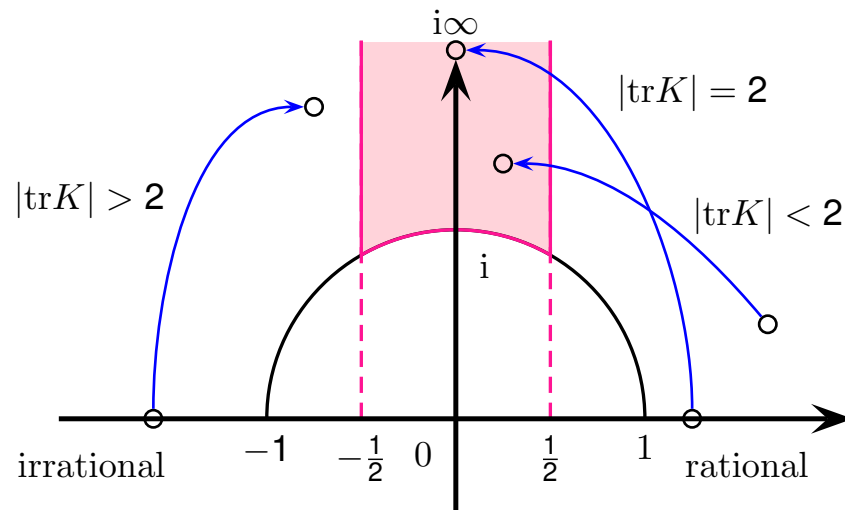

$|\text{tr}K| = 2$: parabolic (collapsible)

$|\text{tr}K| < 2$: elliptic (collapsible)

$|\text{tr}K| > 2$: hyperbolic (non-collapsible)

$\text{tr}K$	monodromy	branes	collapsible?	symmetry	
+2	$T^{-n} = K_A^n$	A^n	yes	$A_{n-1} = SU(n)$	$n \geq 1$
	$\mathbb{1} = T^0 = K_C K_B K_C K_B K_A^8$	$\widehat{E}_9 \equiv A^8 BCBC$	yes	\widehat{E}_9	$n = 0$
	$T^{ n } = K_C K_B K_C K_B K_A^{8- n }$	$A^{8- n } BCBC$	no	$\widehat{E}_{9- n }$	$n \leq -1$
+1	$ST \sim K_C K_A$	$H_0 \equiv AC$	yes	H_0	“~” up to G tf.
	$(ST)^{-1} \sim K_C^2 K_B K_A^7$	$E_8 \equiv A^7 BC^2$	yes	E_8	
0	$S \sim K_C K_A^2$	$H_1 \equiv A^2 C$	yes	$H_1 = SU(2)$	
	$-S \sim K_C^2 K_B K_A^6$	$E_7 \equiv A^6 BC^2$	yes	E_7	
-1	$-(ST)^{-1} \sim K_C K_A^3$	$H_2 \equiv A^3 C$	yes	$H_2 = SU(3)$	
	$-ST \sim K_C^2 K_B K_A^5$	$E_6 \equiv A^5 BC^2$	yes	E_6	
-2	$-T^{-n} = K_C K_B K_A^{n+4}$	$D_{n+4} \equiv A^{n+4} BC$	yes	$D_{n+4} = SO(2n+8)$	$n \geq 1$
	$-\mathbb{1} = -T^0 = K_C K_B K_A^4$	$D_4 \equiv A^4 BC$	yes	$D_4 = SO(8)$	$n = 0$
	$-T = K_C K_B K_A^3$	$A^3 BC$	no	$D_3 = SO(6) \simeq SU(4)$	$n = -1$
	$-T^2 = K_C K_B K_A^2$	$A^2 BC$	no	$D_2 = SO(4) \simeq SU(2) \times SU(2)$	$n = -2$
	$-T^3 = K_C K_B K_A$	ABC	no	$D_1 = SO(2) \simeq U(1)$	$n = -3$
	$-T^4 = K_C K_B$	BC	no	—	$n = -4$

$[p, q]$ -brane is expressed by $z = (p, q)^T$ vector and X_z .

The monodromy matrix K_z is also given as

$$K_z = \begin{pmatrix} 1 + pq & -p^2 \\ q^2 & 1 - pq \end{pmatrix} = \mathbb{1} + zz^T S, \quad S \equiv \begin{pmatrix} 0 & -1 \\ 1 & 0 \end{pmatrix}$$

Re-ordering the branes $X_{z_1} X_{z_2}$:

$$X_{z_1} X_{z_2} = X_{(z_2 + (z_1 \times z_2) z_1)} X_{z_1} = X_{z_2} X_{(z_1 + (z_1 \times z_2) z_2)}$$

$$z_1 \times z_2 \equiv -z_1^T S z_2 = z_2 S z_1 = \det \begin{pmatrix} p_1 & p_2 \\ q_1 & q_2 \end{pmatrix}$$

$$K_{z_2} K_{z_1} = K_{(z_1 + (z_1 \times z_2) z_2)} K_{z_2} = K_{z_1} K_{(z_2 + (z_1 \times z_2) z_1)}$$

Application

SUSY gauge theory by **brane construction** :

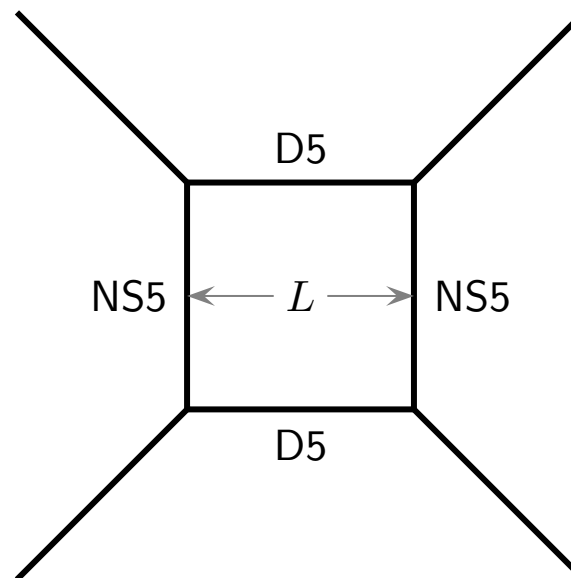

- ✓ N_c D5 between 2 NS5 = $SU(N_c)$ gauge symmetry
- ✓ N_f D5 outside 2 NS5 = N_f flavors

no D7-branes :

5D $\mathcal{N} = 1$ $SU(2)$ Yang-Mills theory on D5-brane

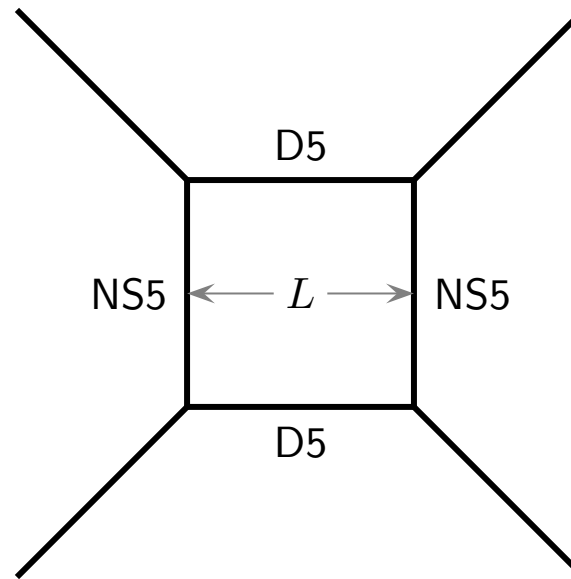

$$\frac{1}{g_{\text{YM}}^2} \simeq \frac{L}{g_s \ell_s^2}$$

no D7-branes :

5D $\mathcal{N} = 1$ $SU(2)$ Yang-Mills theory on D5-brane

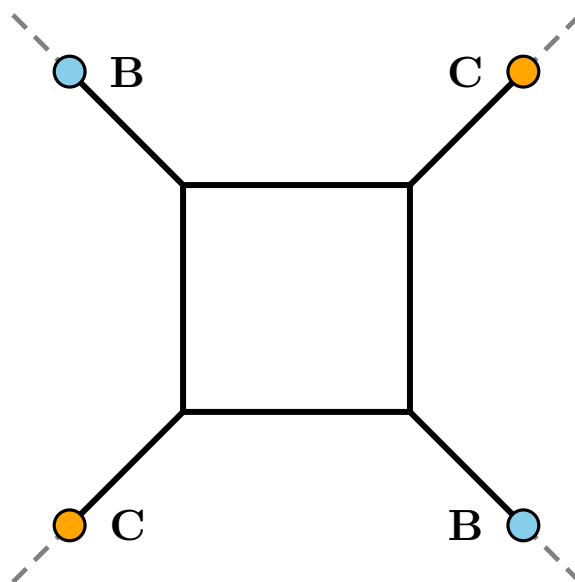

B-brane : $[1, -1]$ 7-brane

C-brane : $[1, 1]$ 7-brane

no D7-branes :

5D $\mathcal{N} = 1$ $SU(2)$ Yang-Mills theory on D5-brane

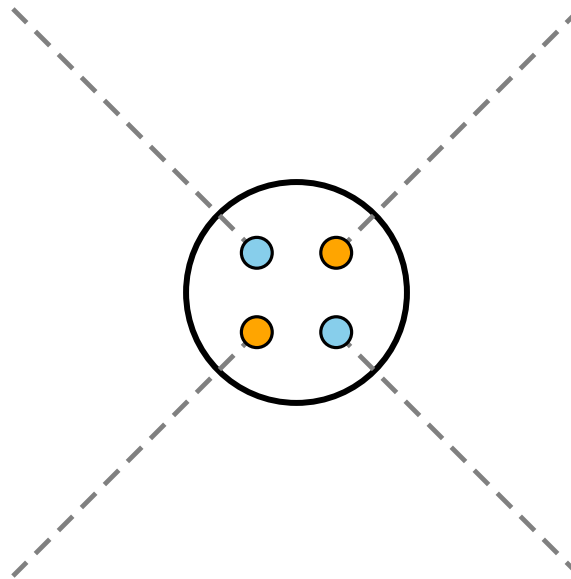

Hanany-Witten transitions

“Box” becomes “loop” by back reactions from **B**- and **C**-branes

no D7-branes :

5D $\mathcal{N} = 1$ $SU(2)$ Yang-Mills theory on D5-brane

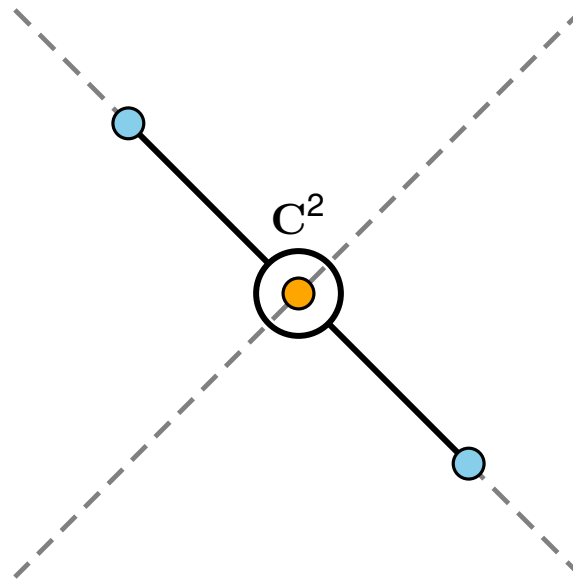

strong gauge coupling limit on 5-branes = small loop limit

$$\ell_s \rightarrow 0, \quad L \rightarrow 0, \quad \frac{L}{\ell_s^2} \rightarrow 0$$

no D7-branes :

5D $\mathcal{N} = 1$ $SU(2)$ Yang-Mills theory on D5-brane

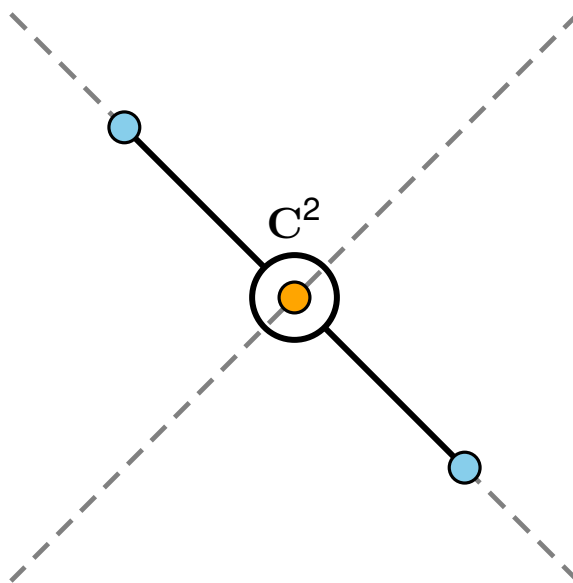

open string ending on 2 C-branes \rightarrow $SU(2)$ symmetry

open string ending on C^2 -branes and “loop” 5-branes \rightarrow flavor symmetry

no D7-branes :

5D $\mathcal{N} = 1$ $SU(2)$ Yang-Mills theory on D5-brane

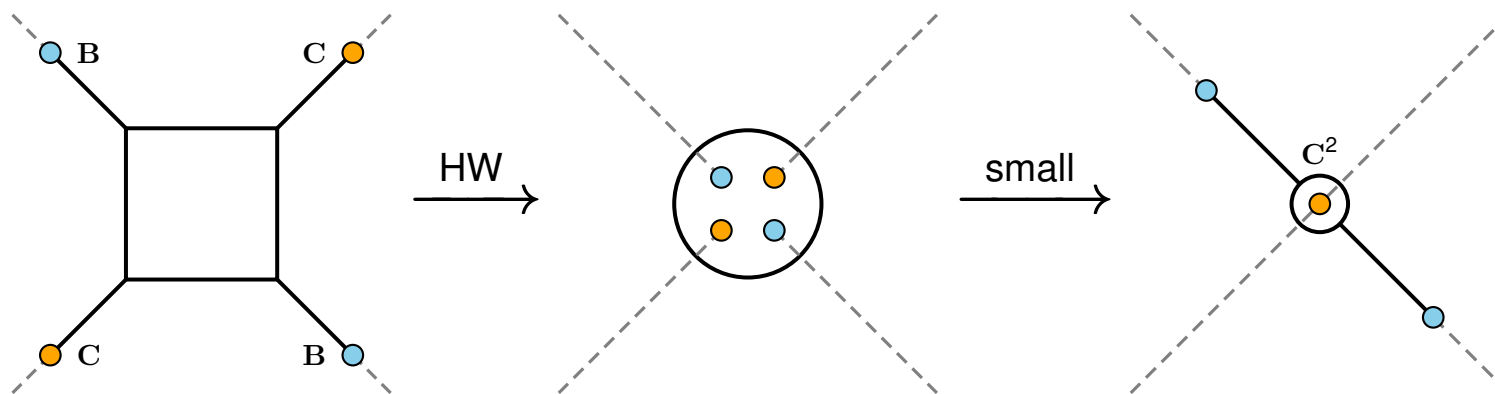

→ SCFT w/ $E_1 \simeq SU(2)$ global symmetry emerges!

1 D7-brane :

5D $\mathcal{N} = 1$ $SU(2)$ gauge theory w/ 1 flavor on D5-brane

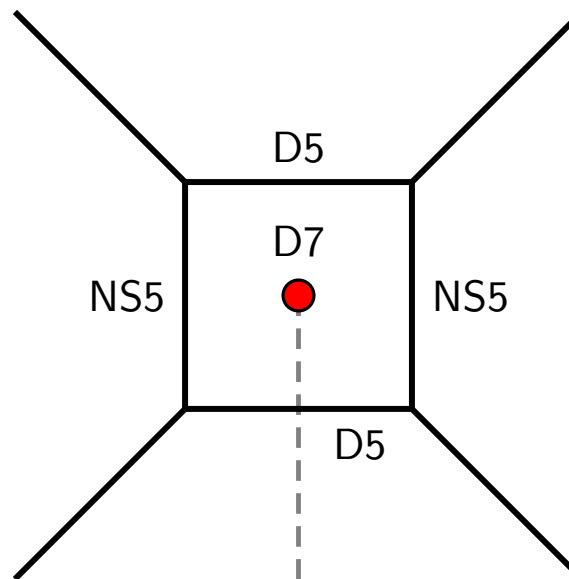

1 D7-brane :

5D $\mathcal{N} = 1$ $SU(2)$ gauge theory w/ 1 flavor on D5-brane

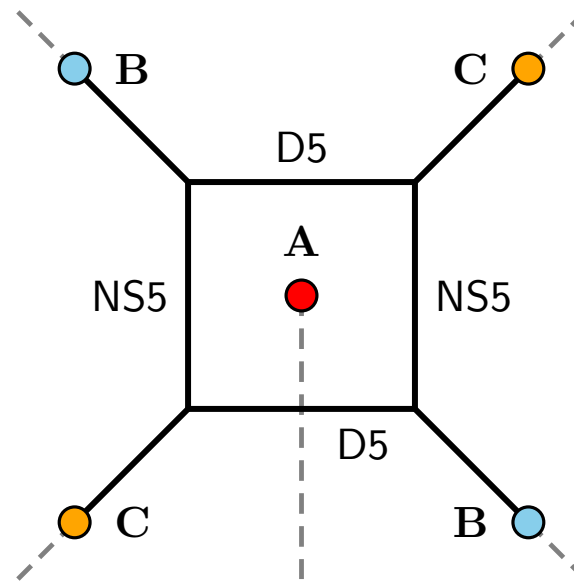

A-brane : $[1, 0]$ 7-brane = D7-brane

B-brane : $[1, -1]$ 7-brane

C-brane : $[1, 1]$ 7-brane

1 D7-brane :

5D $\mathcal{N} = 1$ $SU(2)$ gauge theory w/ 1 flavor on D5-brane

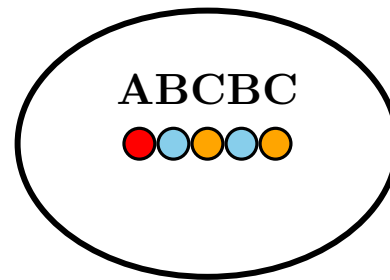

Hanany-Witten transitions

“Box” becomes “loop” by back reaction of ABCBC-branes

1 D7-brane :

5D $\mathcal{N} = 1$ $SU(2)$ gauge theory w/ 1 flavor on D5-brane

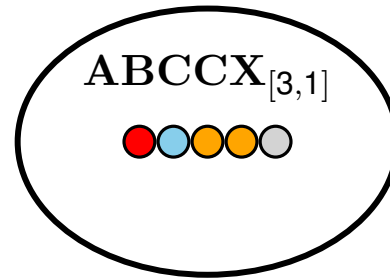

re-ordering of 7-branes : $ABCBC = ABCCX_{[3,1]}$

$X_{[3,1]}$ -brane $\equiv [3, 1]$ -brane

1 D7-brane :

5D $\mathcal{N} = 1$ $SU(2)$ gauge theory w/ 1 flavor on D5-brane

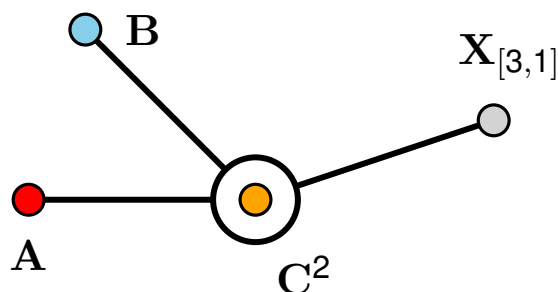

small loop limit

open string ending on 2 C-branes $\rightarrow SU(2)$ symmetry

open string ending on C^2 -branes and “loop” 5-branes \rightarrow flavor symmetry

$$E_2 = SU(2) \times U(1)$$

1 D7-brane :

$SU(2)$ gauge w/ 1 flavor \rightarrow SCFT w/ $E_2 \supset SU(2)$ symmetry

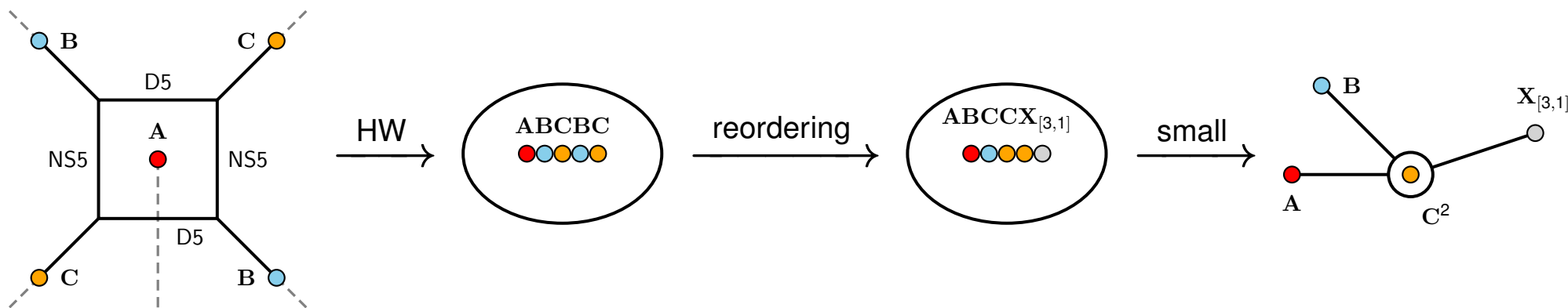
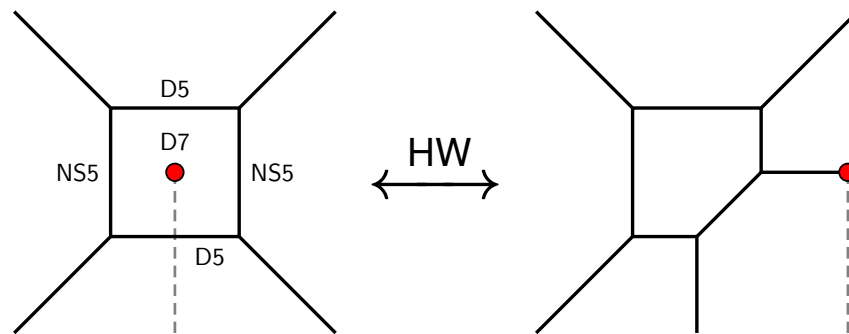

2 D7-branes :

$SU(2)$ gauge w/ 2 flavors \rightarrow SCFT w/ $E_3 = SU(3) \times SU(2)$ symmetry

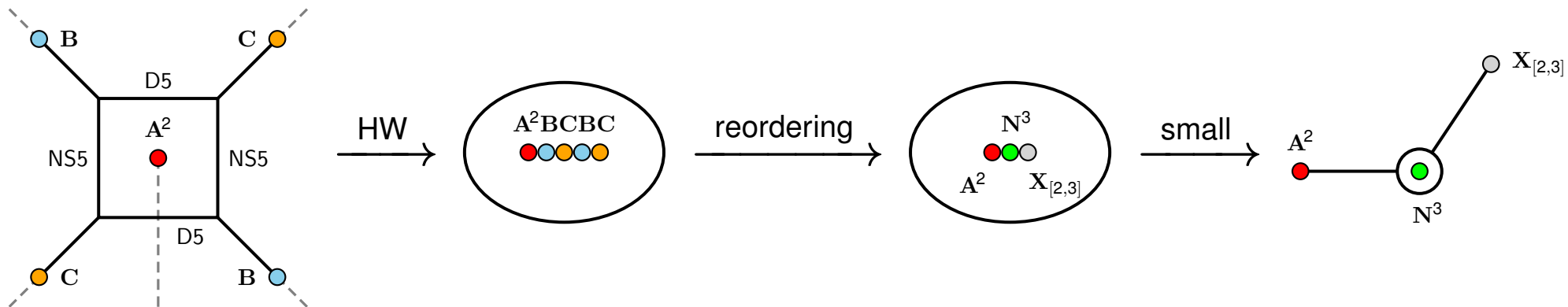

N -brane $\equiv [0, 1]$ -brane

$$A^2BCBC \sim A^2N^3X_{[2,3]} \rightarrow \begin{cases} A^2\text{-brane} : SU(2) \\ N^3\text{-brane} : SU(3) \end{cases}$$

DeWolfe, Hanany, Iqbal and Katz: hep-th/9902179

3 D7-branes :

$SU(2)$ gauge w/ 3 flavors \rightarrow SCFT w/ $E_4 = SU(5)$ symmetry

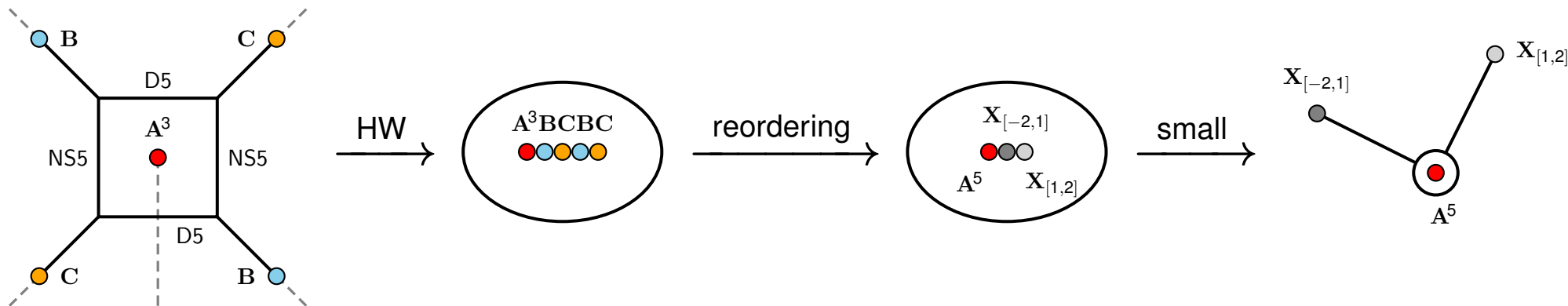

$$A^3BCBC \sim A^5 X_{[-2,1]} X_{[1,2]} \rightarrow A^5\text{-brane} : SU(5)$$

4 D7-branes :

$SU(2)$ gauge w/ 4 flavors \rightarrow SCFT w/ $E_5 = SO(10)$ symmetry

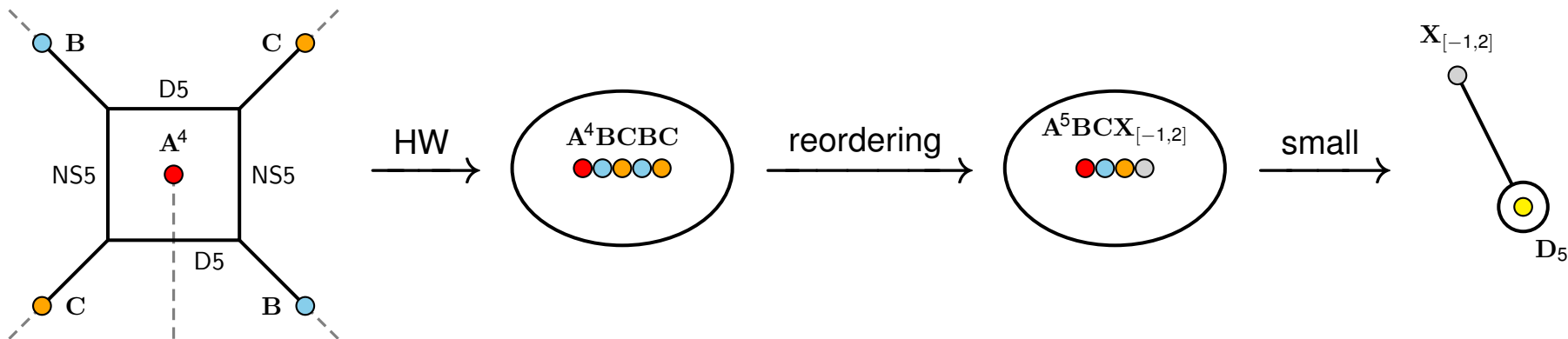

$$A^4BCBC \sim A^5BCX_{[-1,2]} \rightarrow A^5BC = D_5 : SO(10)$$

$n = 5, 6, 7$ D7-branes :

$SU(2)$ gauge w/ $n = 5, 6, 7$ flavors \rightarrow SCFT w/ E_{n+1} symmetry

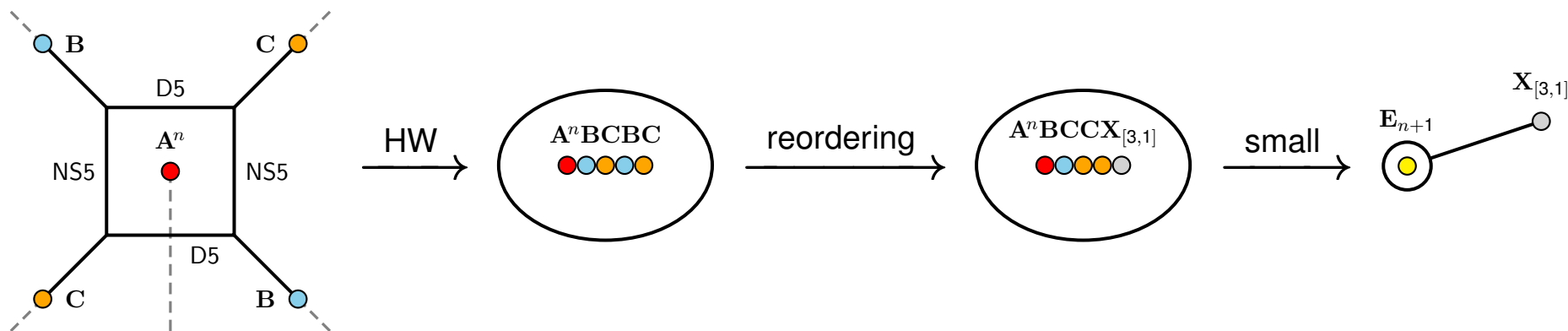

After re-ordering $A^n BCBC = A^n BCCX_{[3,1]}$,

$A^n BCC$ are collapsible at one point! $\rightarrow E_{n+1}$ -brane

EFTs in diverse dimensions :

D	U-duality group	arXiv	D	U-duality group	arXiv
9	$E_{2(2)}(\mathbb{Z}) = SL(2, \mathbb{Z}) \times \mathbb{Z}_2$	1512.06115	5	$E_{6(6)}(\mathbb{Z})$	1312.0614 1412.7286
8	$E_{3(3)}(\mathbb{Z}) = SL(3, \mathbb{Z}) \times SL(2, \mathbb{Z})$	1501.01600	4	$E_{7(7)}(\mathbb{Z})$	1312.4542
7	$E_{4(4)}(\mathbb{Z}) = SL(5, \mathbb{Z})$	1302.1652 1412.0635 1512.02163	3	$E_{8(8)}(\mathbb{Z})$	1406.3348
6	$E_{5(5)}(\mathbb{Z}) = SO(5, 5; \mathbb{Z})$	1504.01523			

$$SL(n + 1; \mathbb{Z}) \subseteq E_{n(n)}(\mathbb{Z}) \text{ in } (11 - n)\text{-dim} : 1402.5027$$